

LCS

3 DIMENSIONS OF EXCELLENCE

● PERFORMANCE ● SCALABILITY ● EFFICIENCY



DATA CENTER
LOCAL AREA NETWORK

THE GLOBAL SPECIALIST
IN ELECTRICAL AND DIGITAL BUILDING INFRASTRUCTURES

 **legrand**[®]

Contents



- 4** | Legrand - A global player
- 6** | Legrand Group - A leading company for all your IT networks
- 8** | Our digital infrastructure expertise

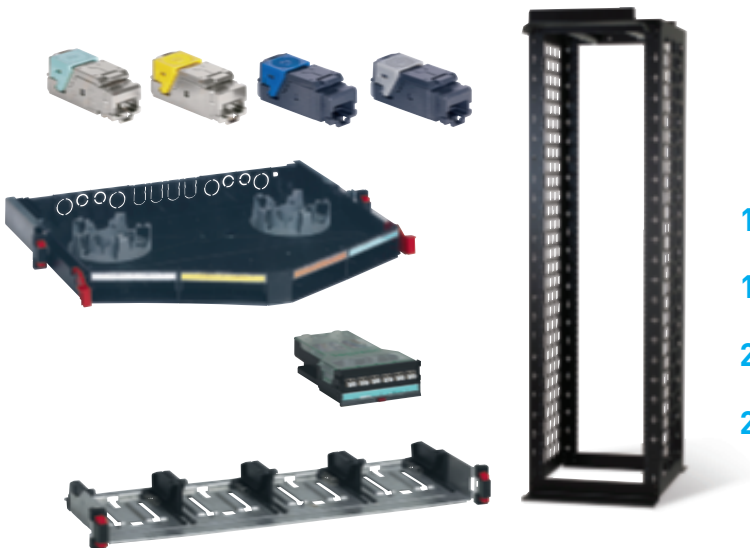

- 10** | Easy installation
- 14** | Scalability & Maintenance
- 22** | Performance
- 26** | Local Area Network

- 28 | Innovative & high-performance PDUs
- 38 | PDUs: measurement, metering & consumption
- 46 | PDUs: accessories for protection



- 48 | Support you can rely on
- 50 | Evolution of standard 11801 Edition 3 – 2018
- 52 | CPR – Construction Products Regulation





Legrand

A global player

Legrand is the global specialist in electrical and digital building infrastructures. The Group offers a comprehensive range of solutions and services tailored to residential,

commercial and industrial applications. The scope of its offering and its leading positions make Legrand a worldwide benchmark.

4 KEY AREAS of expertise

From control and connection interfaces to cable management, energy distribution and data distribution systems, Legrand provides a host of solutions designed to manage lighting, energy, networks and building access.



AN ACTIVE INTERNATIONAL PRESENCE

ESTABLISHED
IN OVER
90 COUNTRIES

SALES IN
CLOSE TO **180**
COUNTRIES

TURNOVER

NEARLY
€6 BILLION

OVER **38,000**
EMPLOYEES

INNOVATION

4.8 % OF
SALES
INVESTED
IN R&D

A WIDE CHOICE
OF SOLUTIONS
OVER **300,000**
CATALOGUE
ITEMS

MORE THAN
70 BRANDS

DIGITAL INFRASTRUCTURE

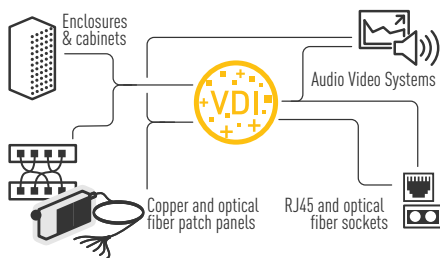

CONTROL AND COMMAND

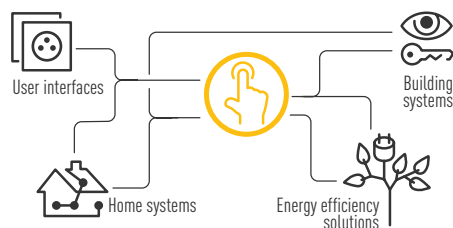

CABLE MANAGEMENT

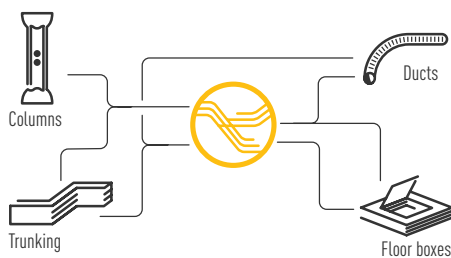

ENERGY DISTRIBUTION

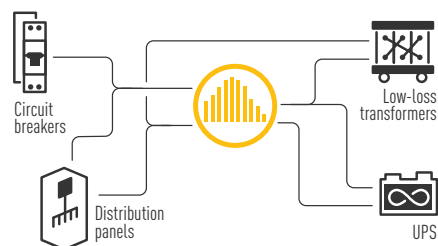



Legrand Group

A leading company for all your IT networks

Legrand cabling systems currently provide high-quality connectivity to more than 200 million devices. The Legrand Group is a world leader in communication networks for data transmission. Its investment in the

development and design of structured cabling systems and solutions has enabled it to expand its offer and achieve the highest level of performance. These solutions are ideal for today's multimedia networks, technologies and applications.



GLOBAL PLAYERS DATACOM IT

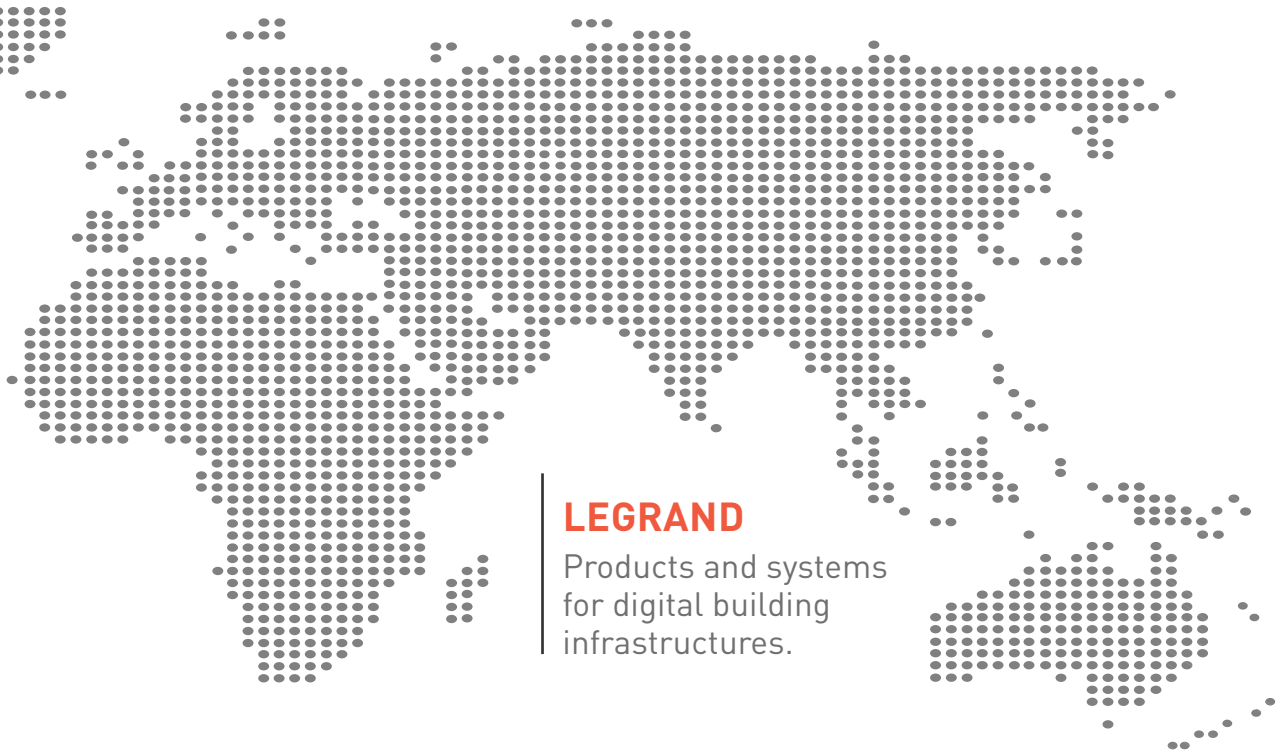

LEGRAND

Products and systems
for digital building
infrastructures.

A PORTFOLIO OF SPECIALIST BRANDS

- C2G • Electrorack • Estap • Minkels • Raritan • Server Technology Inc.
- SJ Manufacturing • Starline • Valrack



Our digital infrastructure expertise

Legrand's complete global solutions for data communication perfectly address the key challenges for digital networks: performance, scalability and efficiency.

1

LOCAL AREA NETWORKS



SOLUTIONS FOR STRUCTURED CABLING

- **Housing solutions**
 (19" freestanding and wall-mounting cabinets, open racks, PDUs, micro data centers, etc.)
- **Copper solutions**
 (RJ45 connectors, patch panels, cables and patch cords, PoE switches, etc.)
- **Fibre solutions**
 (Connectors, equipped & modular panels, bend-insensitive cables, etc.)



2 DATA CENTER & SERVER ROOM



SOLUTIONS FOR STRUCTURED CABLING IN SERVER ROOMS

- **Housing solutions**
(Server cabinets, aisle containment, cooling units and cold corridor, open racks, PDUs, etc.)
- **Copper solutions**
(Preterminated, etc.)
- **Fibre solutions**
(Preterminated, intelligent patching, high-density fibre optic solutions, etc.)



3 AUDIO VIDEO SYSTEM



A WIDE RANGE OF TECHNOLOGIES TO SUIT THE LOCATION AND THE USER EQUIPMENT

- **Racks and enclosures**
- **Preterminated audio/video sockets**
(HDMI, display port, HD15, USB, RCA, JACK, etc.)
- **Cords and adaptors**



Easy installation

1 TOOLLESS

2 A PERFECT
CONNECTION

3 FAST-ON CONNECTIONS
IN PATCH PANEL

COPPER SYSTEM RJ 45 connectors

The **TOOLLESS CONNECTORS** with toolless fast connection are available in all categories for installation both on patch panels and in the workstation. A perfect connection can be obtained in a few seconds, guaranteeing optimum performance of the link from the patch panel to the workstation. They are colour-coded so their category can be safely identified:

- Cat. 5e: grey
- Cat. 6: blue
- Cat. 6A: yellow
- Cat. 8: aqua

PATENTED
DESIGN

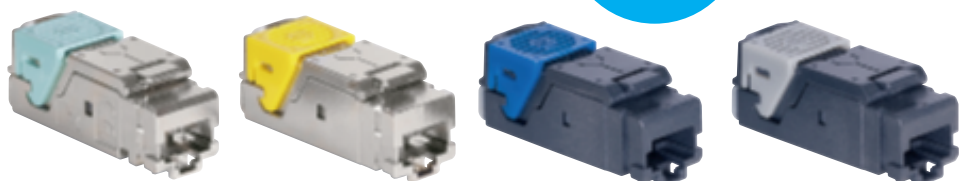

Innovative systems to facilitate wiring and installation and increase the data transfer speed with both the copper solution and the fibre optic solution.

TOOLLESS CONNECTOR CONNECTION PHASES

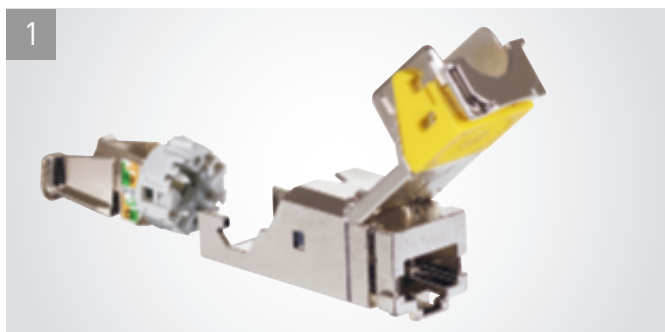

1 Take the wire housing



2 Pass the cable through the back of the wire housing

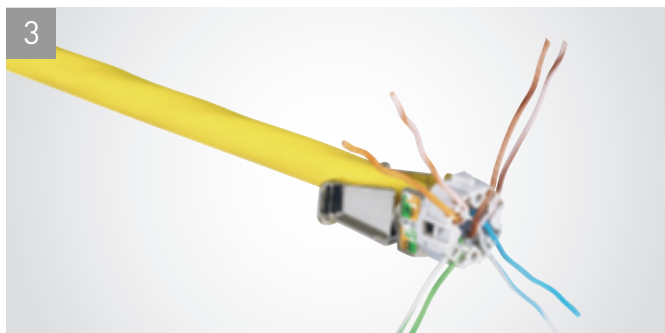

3 Separate and insert the pairs



4 Cut the pairs

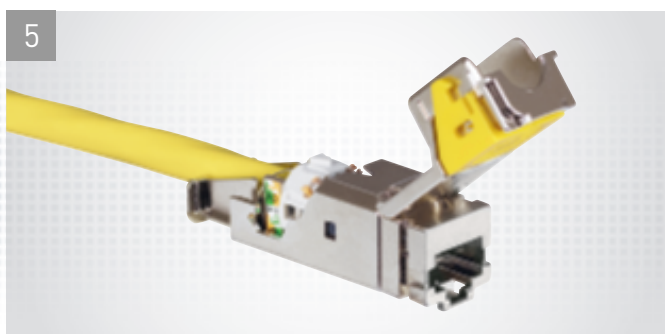

5 Install the wire housing without pushing



6 Push down the lever and lock the connector



Easy installation

FIBRE OPTIC Cassettes

Legrand has launched innovative splicing cassettes which can be removed automatically by simply pressing them, simplifying installation and maintenance.



- For installation directly in modular panel Cat. No 0 321 40.
- The splicing cassettes are removable from the front.

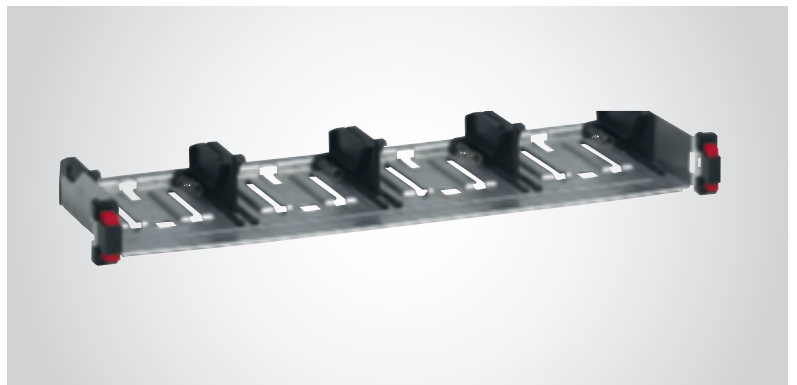

READY TO BE USED IN 1 CATALOGUE NUMBER!

- Pre-equipped cassettes with fitted fibre optic block (SC duplex or LC duplex, monomode or multimode)

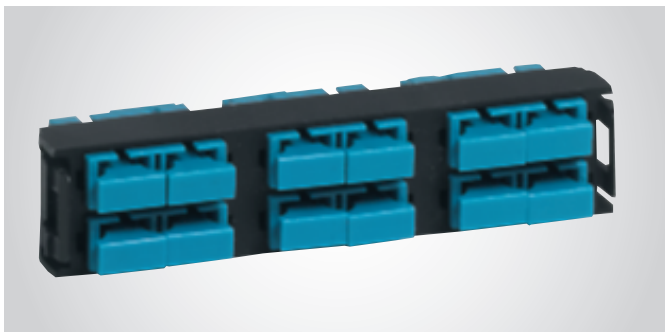

SC duplex high density fibre optic block for 12 multimode fibre optics

- Supplied with sets of 6 or 12 pigtailed

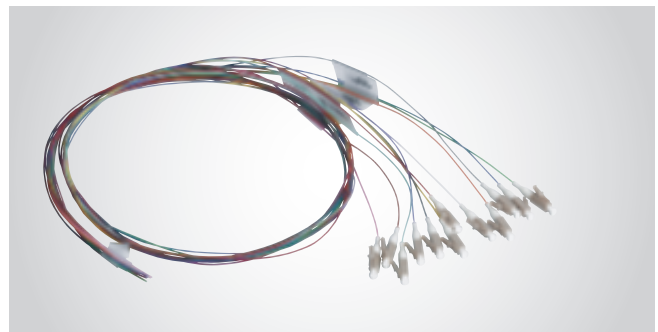

Set of 12 OM3 LC-PC pigtailed

- A very large offer of pigtailed in 1 or 2 meters ; in OM3, OM4, OM5 on-demand, OS2 (OS1a compatible). Sets of 12 LC pigtailed in OM3, OM4, OS2 (OS1a compatible)

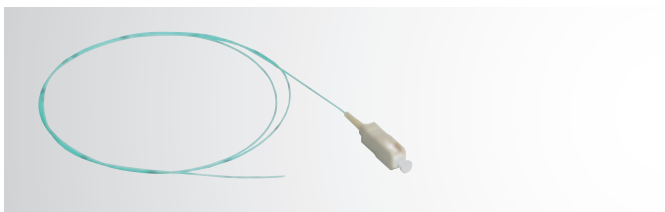

OM3 (PC) pigtailed, SC connectors

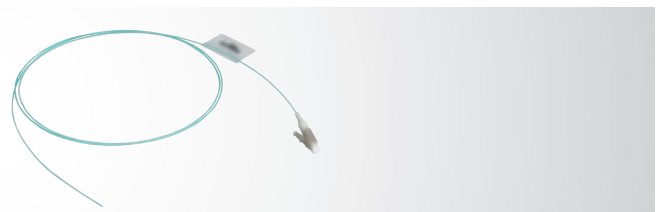

OM4 (PC) pigtailed, LC connectors

Scalability & Maintenance

1 SLIDING CASSETTE:
EASIER MAINTENANCE

2 INNOVATIVE MODULAR
CASSETTE

3 FAST PUSH-BUTTON
EXTRACTION

Innovative systems to facilitate wiring and installation and increase the data transfer speed with both the copper solution and the fibre optic solution.

COPPER SYSTEM Patch panels

The patch panels have been designed and produced to optimise space, with up to 48 ports per unit, and make maintenance and future upgrades easier. They are available in both flat and angled versions. They have a quick system for pulling out the unit and an innovative cable guiding system for tidy and easy cable management.

INNOVATIVE CASSETTES

- Sliding cassettes: easier maintenance
- Fast push-button extraction
- Innovative modular cassette system
- Easy maintenance: remove connectors without disconnecting the cords
- **Easy to mix with Legrand fibre optic solutions**



48 ports per unit

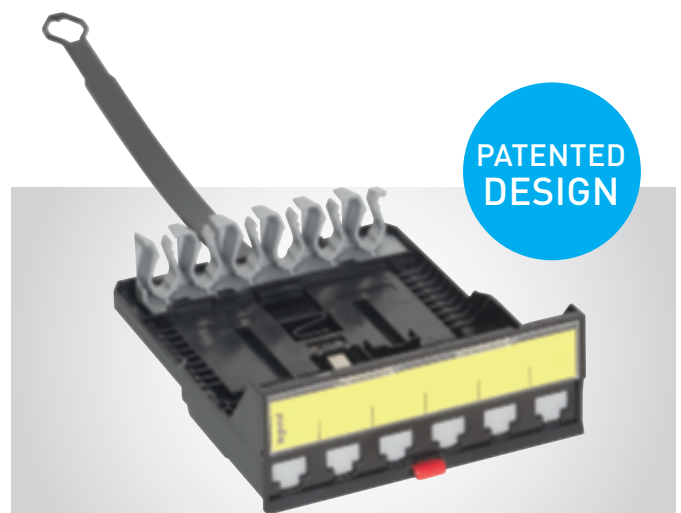

Cassette up to 12 connectors for patch panel

QUICK-FIX SYSTEM



Innovative quick-fixing solution:

- Push and connect system
- Automatic earth connection
- In-rack cabling optimised
- Accessory for patch cords with rotating system for angle adjustment and label holder

Compatible with all panels (Flat, angled, HD)

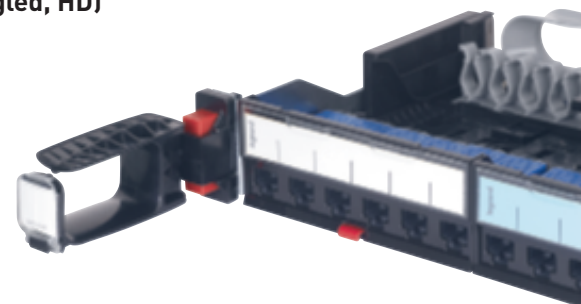

10" PATCH PANELS

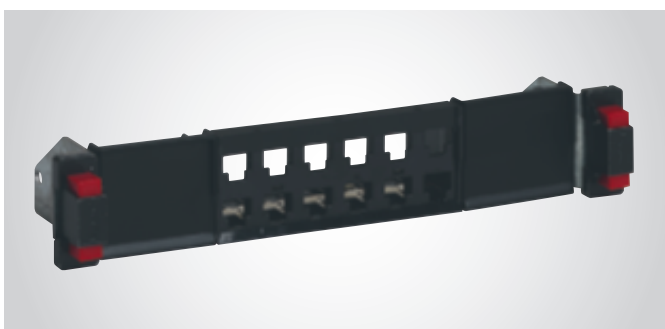

- With 6 or 12 ports for small & medium installations
- Integration of all LCS³ connectors
- Automatic earth connection & quick-fixing system

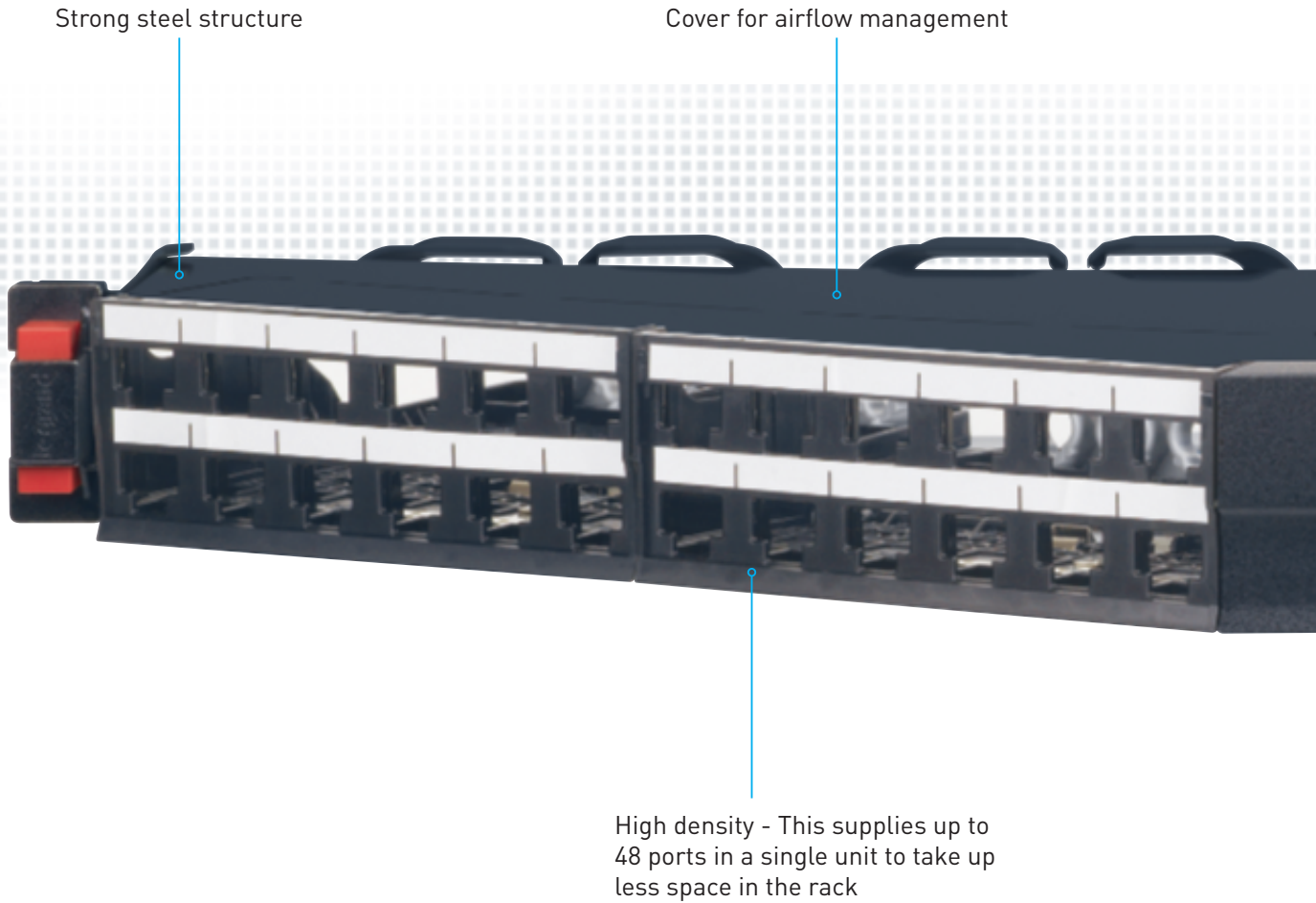

**ANGLED PATCH PANEL
SOLUTION FROM 24 TO 48
PORTS PER UNIT**

Patch panels with an angled design which allow the cable to run into each side of the rack, creating a correct cable radius of curvature. This avoids the need to manage the cables horizontally, and allows the patch cords to be carried directly in the vertical cavities.



Tidy cable management

Quick-fix system

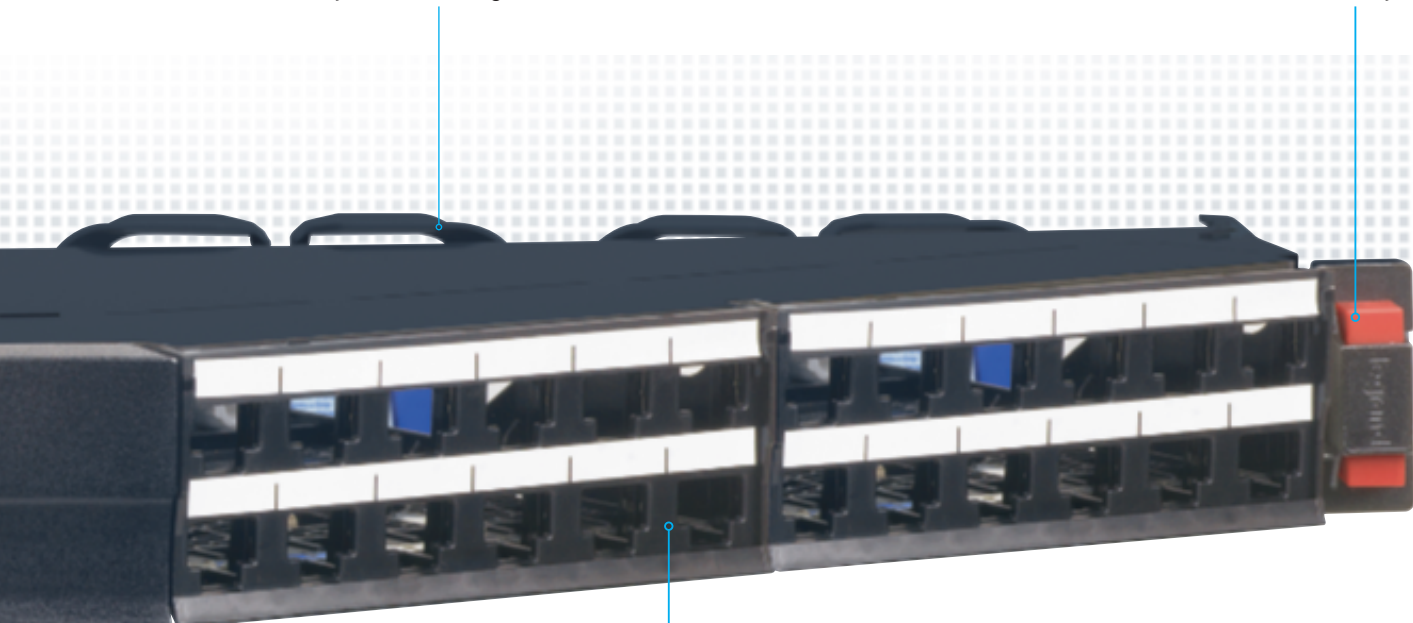

Simple and efficient
identification of the ports



Also available
in the 24-port version

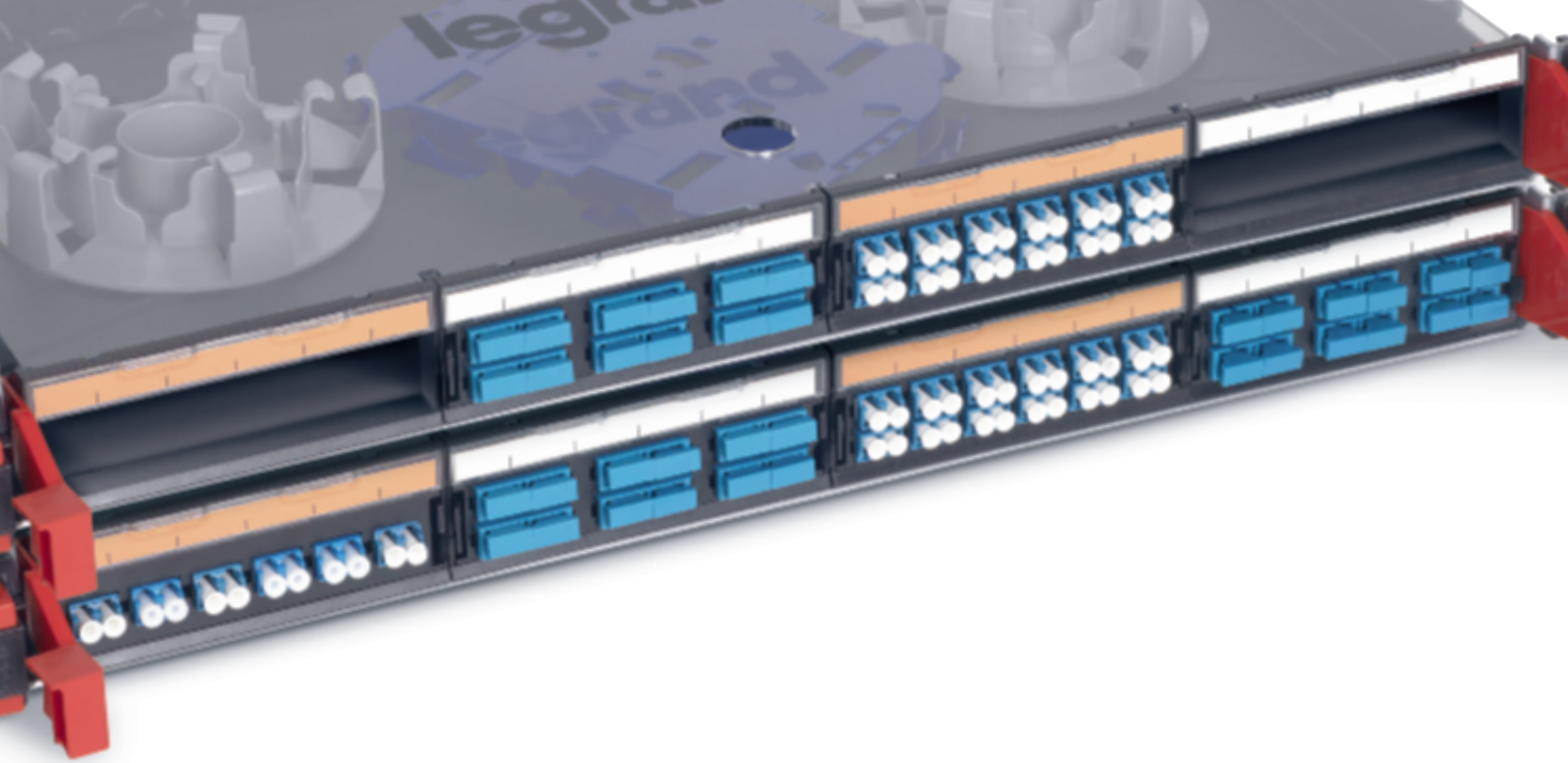

FIBRE OPTIC Panels

Completely renovated and redesigned fibre optic panels & drawers in high and very high density versions from 96 connectors per unit to 144 connectors per unit. Panels with sliding drawers and fast push-button system to facilitate upgrade and maintenance operations.

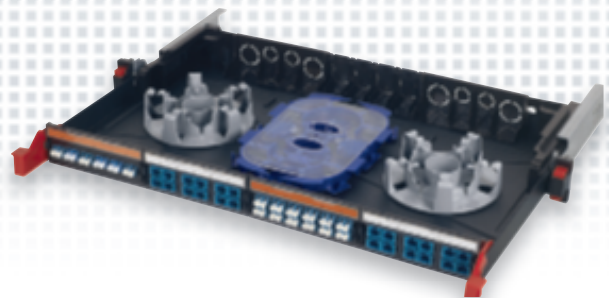

MODULAR PANELS

- Possible to change modular blocks, blank panel, MTP adaptor
- Splice trays to be added if necessary - up to 4 containing 96 LC fibres

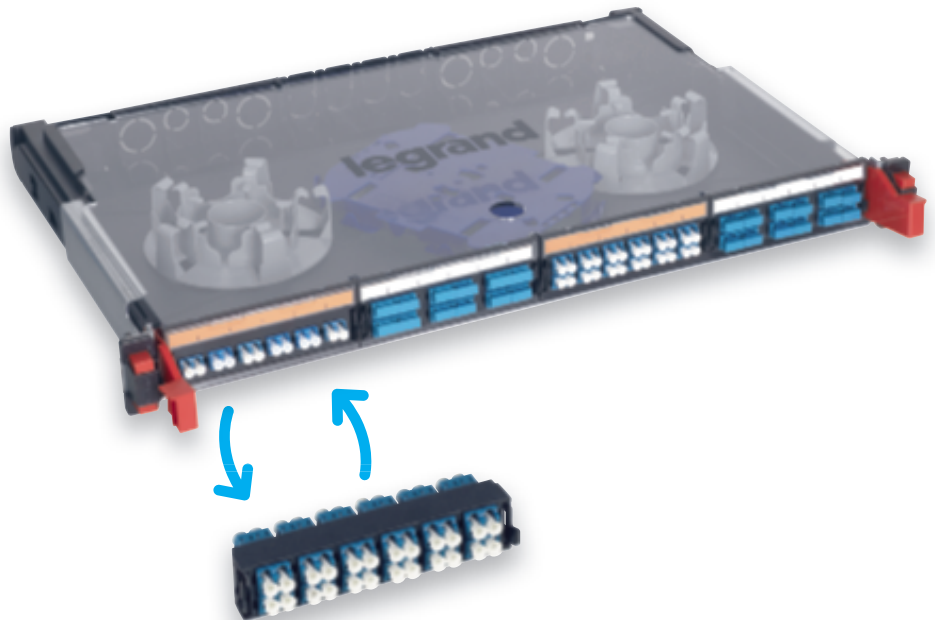

HD MODULAR PANELS

- Innovative quick-fixing solution
- Possible to add splicing cassette with perfectly adapted coiling space
- Mix of fibre/copper on modular panel in drawer

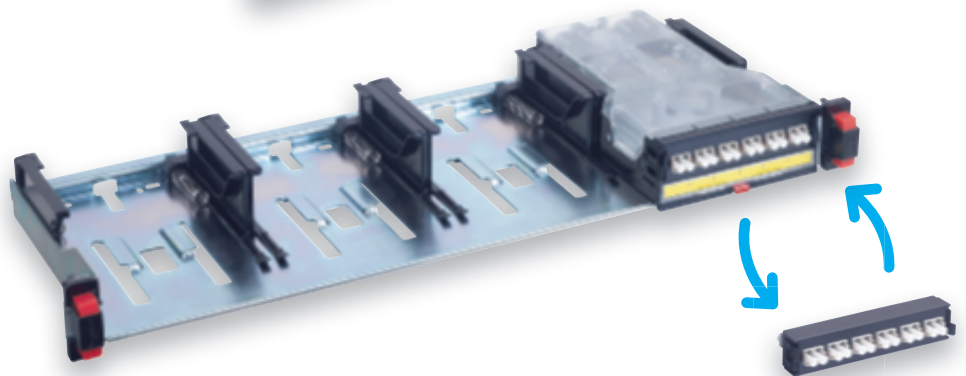

ZERO-U KIT

- Innovative Zero-U kit for universal fixing to give flexibility and space optimization



FIBRE OPTIC Panels

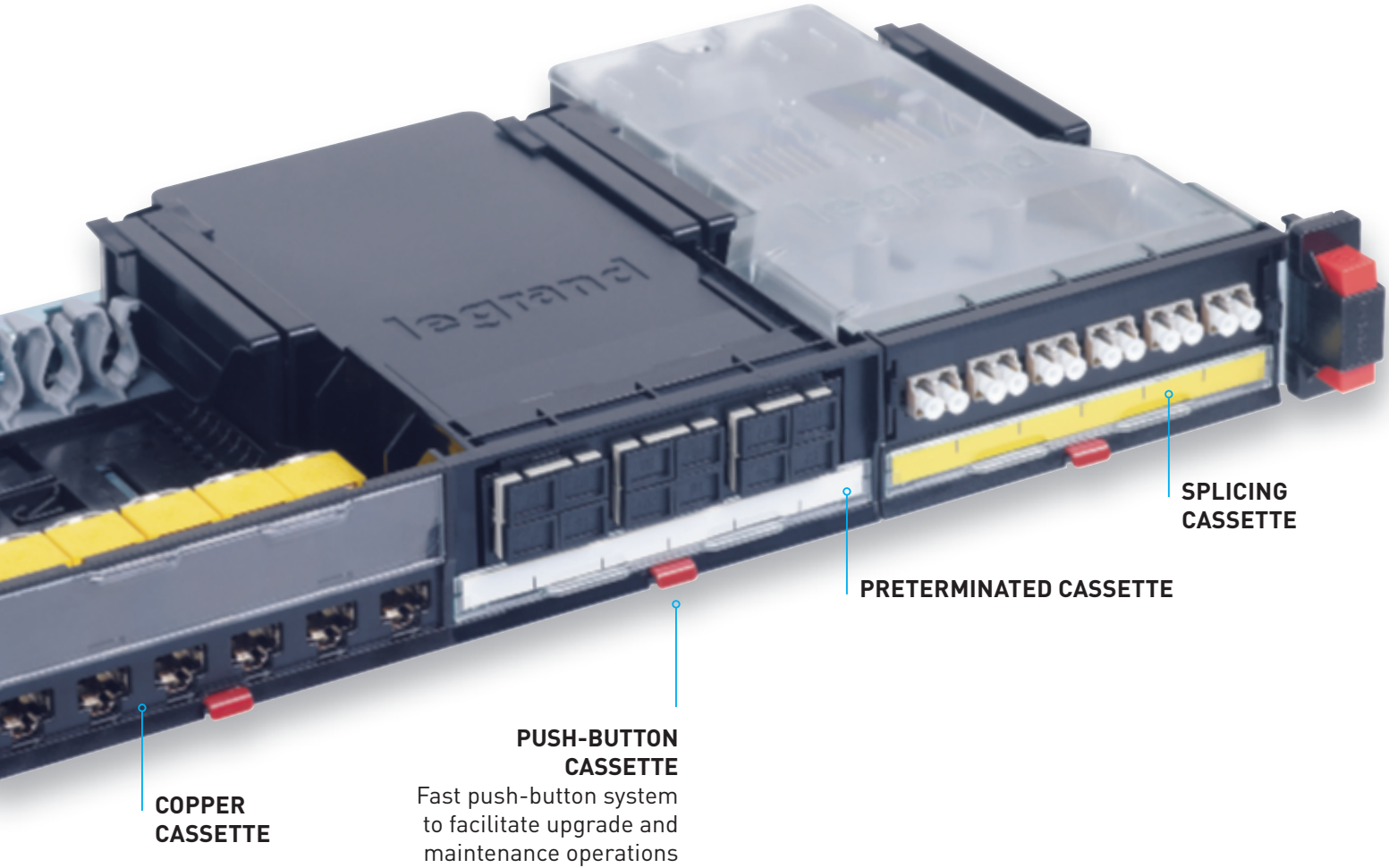



MODULAR PANELS

- Innovative quick-fixing solution
- Modular blocks to adapt to modular panel or drawer: LC, SC, ST, LC, APC, SC APC
- Possible to add modular blocks, blank panel, MTP adaptor

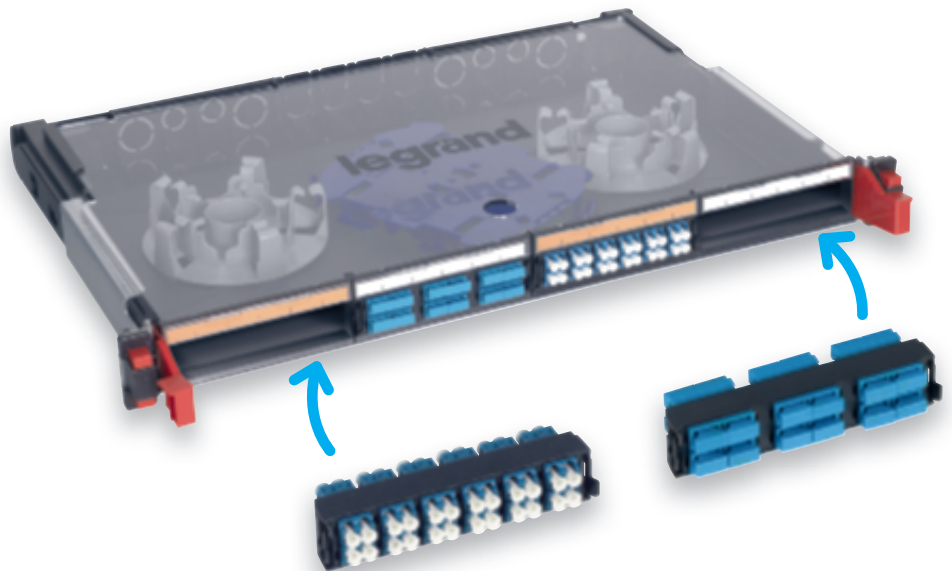

HD MODULAR PANELS

- Cassettes slide in from front & rear
- Fast push-button on cassette
- Splicing cassette which takes all modular blocks
- Mixture of fibre/copper on cassette panel
- Trunk & cord management system

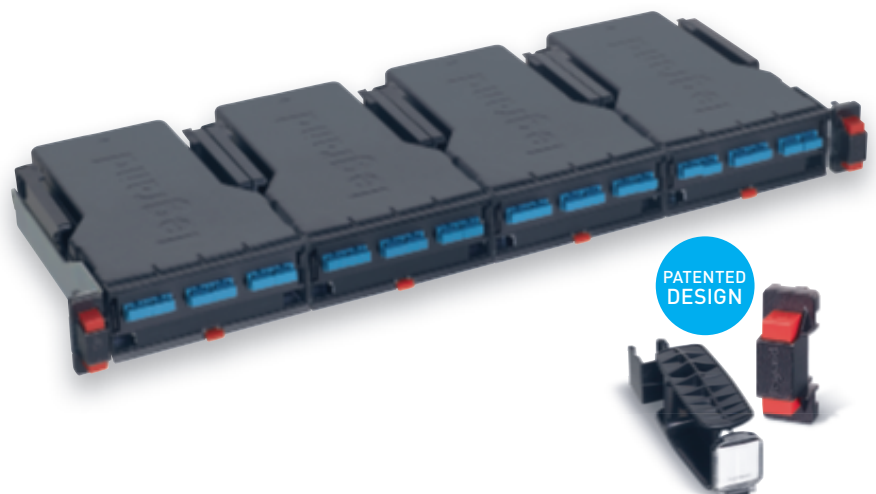

Performance

Legrand's LCS³ system offers you

- 1 25 Gbps and 40 Gbps Ethernet applications
COPPER SYSTEM
- 2 40 Gbps and 100 Gbps Ethernet applications
FIBRE OPTIC SYSTEM
- 3 MTP/MPO high density and up to Cat. 8 solutions
FIBRE OPTIC & COPPER SYSTEMS

When describing the performance of a structured cabling system, irrespective of the technology used for the conductor (copper or fibre optic), the transmission speed (Bit rate) is the reference point.

COPPER SYSTEM

The cable is one of the most critical components in horizontal wiring for the performance of the whole link, in terms of both quality of the product and conformity of the installation.

Any cable installation error will seriously compromise performance of the installation.

For structured cabling systems, the standard requires the use of category 5e, 6 and 6A (100 MHz, 250 MHz and 500 MHz respectively) twisted, symmetrical 4-pair cables with an impedance of 100 Ω¹⁾.

The cable can be of the following type:

- Unshielded U/UTP (Unshielded Twisted Pairs)
- Shielded F/UTP (Foiled Twisted Pairs)
- Double shielding SF/UTP or S/FTP.

NOTE 1): To date, category 7 is not very widely used, even though it is standardised and can offer high performance levels. It is used for reasons of form factor, cost and where there are installation difficulties.

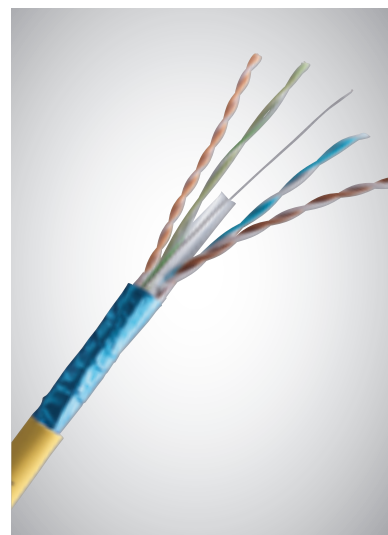

EXAMPLES OF LEGRAND CABLES

	Sheath	Storage/installation temperature	Operating temperature
Cat. 6A F/UTP 100 Ω	LSZH (zero halogen cables) conforming to standard NFC 32062, flame retardant conforming to standards IEC 332-1 and NFC 32070	0 to +50°C	-20 to +60°C
Cat. 6 U/UTP 100 Ω	PVC or LSZH cables conforming to standard NFC 32062, flame retardant conforming to standards IEC 332-1 and NFC 32070	0 to +50°C	-20 to +60°C
Cat. 6 F/UTP 100 Ω	PVC or LSZH cables conforming to standard NFC 32062, flame retardant conforming to standards IEC 332-1 and NFC 32070	0 to +50°C	-20 to +60°C
Cat. 5e U/UTP 100 Ω	PVC or LSZH cables conforming to standard NFC 32062, flame retardant conforming to standards IEC 332-1 and NFC 32070	0 to +50°C	-20 to +60°C

NOTE: For all other types of cable, please contact the Legrand sales network



FIBRE OPTIC SYSTEM

Fibre optic is a transmission medium that enables a larger bandwidth to be used than copper cables. With fibre optic cables, transmission is based on the propagation of light pulses, generated by an LED or a laser source in the infrared band, along a glass fibre. Inside an optical fibre, the signal can either be propagated in a straight line, or be reflected many times. Straight line propagation mode is said to be zero order. Singlemode fibres only use one mode to propagate light. The diameter of their cores is between 8 and 10 μm . Multimode fibres allow several propagation modes, and the diameter of their cores is 50 μm or 62.5 μm (the latter is hardly ever used now).

The diameter of the cladding is usually 125 μm . Multimode fibres are used in indoor installations and enable more economical devices to be used. They are however subject to the phenomenon of modal distortion, when the different modes propagate at slightly different speeds, which limits the maximum distance at which the signal can be received correctly.

Singlemode fibres are used in outdoor installations as they can cover much longer distances and reach much higher speeds.

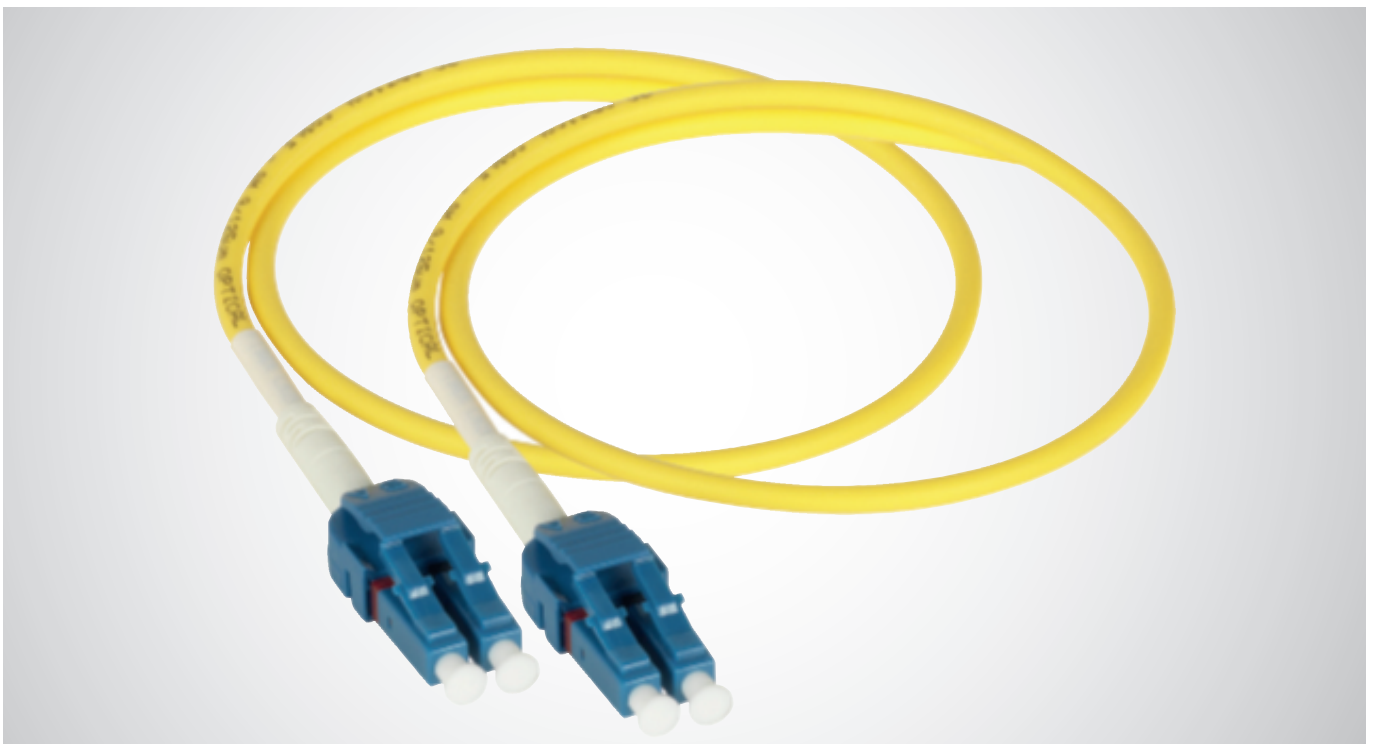
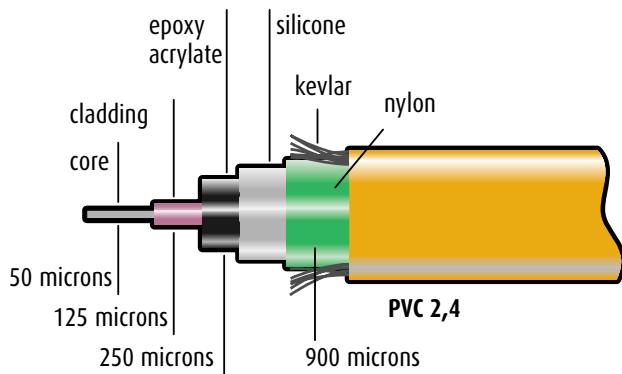
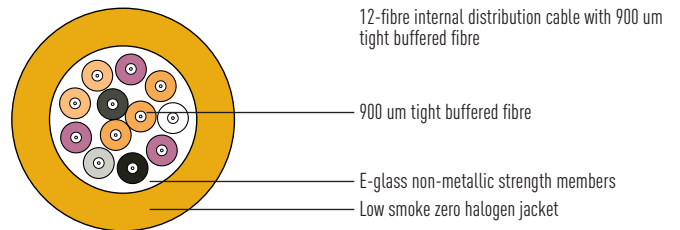

DIAGRAM OF A SINGLE-FIBRE CABLE



EXPLODED VIEW OF A MULTIFIBRE CABLE CONTAINING 6 SINGLE FIBRES



Multimode optical fibre

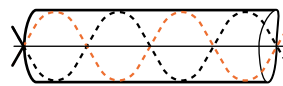

Diameter of the core: 50-62.5 μm
Diameter of the cladding: 125 μm

Singlemode optical fibre

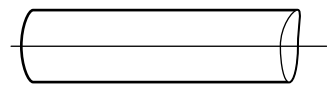

Diameter of the core: 8 to 10 μm
Diameter of the cladding: 125 μm

PERFORMANCE ACROSS THE SYSTEM WITH ON-DEMAND PRETERMINATED SOLUTIONS

Connectivity	Standard density (HD)	Modular density (HD)
DRAWERS		
TRUNKS	<p>Types of trunks</p> <p>Tight Buffer Loose Tube Loose tube corrugated steel tape Breakout Fan-out Micro-cable 250 microns</p> <p>TYPE OF FIBRE OS1a/OS2, OM1, OM2, OM3, OM4, OM5 (on demand), etc.</p> <p>NUMBER OF FIBRES 2, 4, 6, 8, 12, 16, 24, On demand, etc.</p> <p>CHOICE OF TERMINATION LC, SC, SC APC, MTP etc.</p> <p>PLEASE CONTACT US for any specific requirements.</p>	
CABLES/PATCH CORDS	OM2, OM3, OM4, OM5 (on demand) & OS2	

Local Area Network

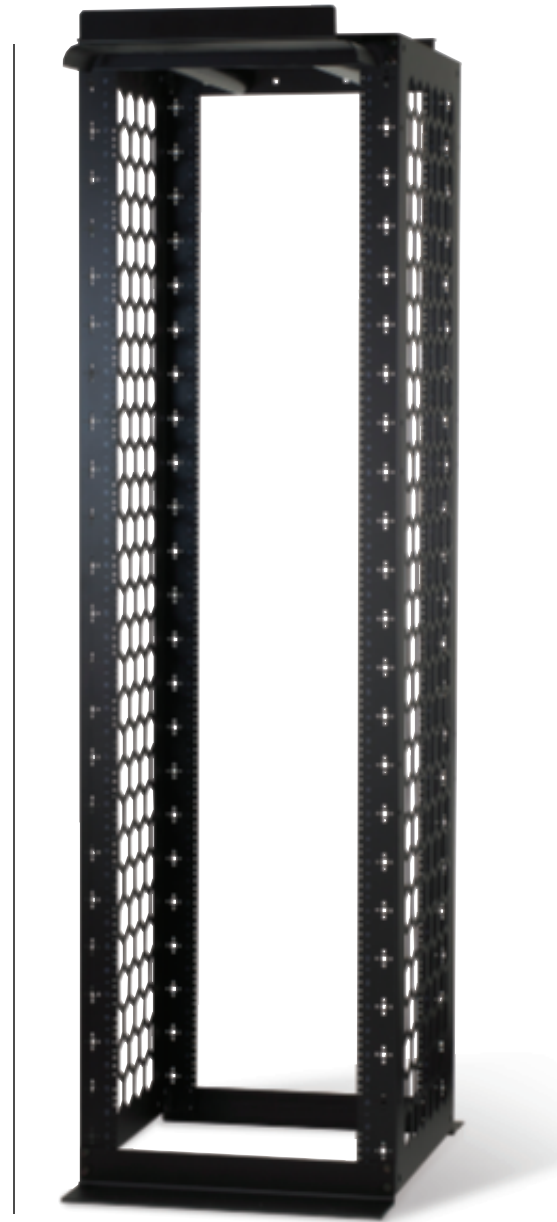

LCS³ CONNECTIVITY RACK

Open racks provide greater flexibility and optimum efficiency in any data center. The fixed racks provide an economical mounting platform for switches and servers while the adjustable rack allows all 4 mounting rails to be adjusted even after the rack has been fastened to the floor. Front waterfalls allow for equipment patching and server patching. Vertical managers can be mounted front and rear for a perfect management of patch cords.



LCS³ CABLING RACK

Given how quickly IT technology evolves, a flexible, future-proof concept is essential. The LCS³ cabling rack is specifically designed to meet these needs and stands out due to its versatility, ease of installation and ease of use.

The LCS³ cabling rack is a multifunctional system, specifically designed for ease of installation. The system is ultimately suitable for housing UTP-patch panels, glass drawers, telephone panels, switches, routers and other IT equipment. Of course it is also possible to include a small number of servers.



LCS³ WALL ENCLOSURE

The basic frame is made up of a wall-mounting plate with integrated strain relief bar, four depth rails, two cable-entry plates (base and top) and a set of 19-inch rails. The assembly consists of two equal top and base panels with ventilation slots to the rear, two equal side panels and a safety glass door with an EK-333 cylinder lock with grip.

Innovative & high-performance PDUs

GENERAL CHARACTERISTICS

- Anodised aluminium Chassis:
 High-quality material, lightweight and rigid
- Modular design:
 Expandable socket and function modules

SAFETY

- High-quality electrics
- High-quality connection
- Sockets equipped with safety shutter
- Cord Locking system

POWER SUPPLY

- 16 A to 32 A, single - or three - phase
- PDUs incorporating both
 international and local type sockets



STANDARDS

- IEC 60950** - Information technology equipment - Safety
- IEC 60297-3** - Dimensions of mechanical structures of the 482.6 mm series (19 in)
- IEC 60320-2-2** - Appliance couplers for C13 and C19 electrical equipment
- IEC 60884-1** - French/Belgian and German standard plugs/sockets
- BS 1363-2** - British standard plugs/sockets
- IEC 60309** - Industrial plugs

Certification: CE, TSE, CCC

Environmentally-friendly products
 Eco-design



SOLUTIONS FOR ANY CONFIGURATION

A wide universal range

The PDU offer combines Legrand's quality and innovation with a wide range of applications. A standalone solution, this range integrates seamlessly into any installation, ensuring compliance with applicable standards.

ZERO-U PDU

P.34 to 35



FOR DATA CENTERS/SERVER ROOMS

These are used in server cabinets where:

- there is a high density of active equipment
- electrical distribution quality is crucial

For vertical installation



1-U PDU 19"

P.36 to 37



FOR DATA CENTERS, EDGE SERVER ROOMS AND COMPUTER ROOMS

These are used in patching and server enclosures where:

- there is a low density of active equipment to be powered
- ease of installation is an advantage

For vertical or horizontal installation

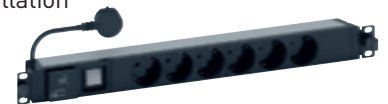

1-U PDU 10"

P.36



FOR SMALL IT ENVIRONMENTS

These are mainly used in small-scale commercial applications where there are a limited number of computer workstations and a 10" cabinet is sufficient:

small businesses, freelance professions, administrative services, etc.

For horizontal installation





Legrand Metered and Switched models provide the most common power supply configurations to meet the needs of data centers and local networks.

BASIC PDUs

P.34 to 37



ENERGY DISTRIBUTION

For implementation in LANs or data centers, these are easily mounted and have numerous configuration options

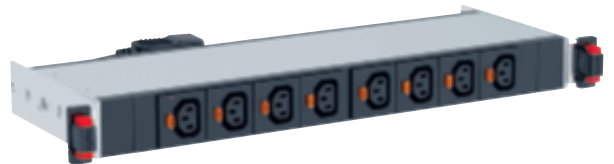

AVAILABLE IN VERTICAL ZERO-U
 AND HORIZONTAL 1U 19" VERSIONS

EFFICIENT POWER SUPPLY MANAGEMENT

Incorporating intelligent, innovative functions

PDUs can help meet the needs for energy while incorporating intelligent functions, including real-time power metering and environmental monitoring. Connected PDUs (iPDUs) include measurement of consumption and switching of active power and remote alarm with volts, amperes, real-time power (kW) and energy (kWh) measurements.

METERED & SWITCHED iPDUs P.40 to 45



POWER SWITCHING AND REAL-TIME MONITORING

With input metering and output level switching, these can be used to remotely control the power of devices and supply the necessary information as needed. Multiple configurations are available

METERED iPDUs P.44



ACCURATE MEASUREMENT

With input metering, Legrand PDUs can provide accurate energy consumption measurements. Multiple configurations possible

PDU FUNCTIONS BY RANGE	BASIC	METERED	SWITCHED
Phase measurement (kWh, V, A, PF)	•	•	•
Circuit breaker trip detection		•	•

**CORD LOCKING SYSTEM
 INNOVATION AT THE
 HEART OF PDUs**
 For C13 & C19
 socket outlets

Security of cable connection at rack level is a critical element which must be considered to ensure longevity of the installation. All Legrand PDUs have a power supply cord locking system which prevents accidental disconnection due to human error or vibration and guarantees absolute safety.
 Function integrated in all Legrand PDUs: Basic, Metered, Metered and Switched.



EASY IDENTIFICATION



Very easy to identify thanks to the orange buttons next to each socket outlet

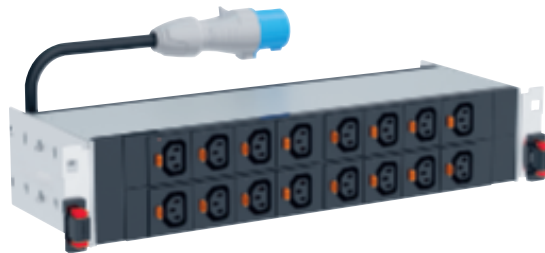

AN INNOVATIVE TECHNICAL SOLUTION



CORD CONNECTION

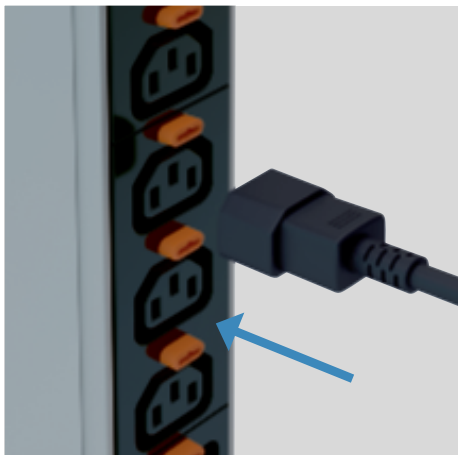

The cord is connected to the socket naturally in one smooth action

AUTO LOCKING

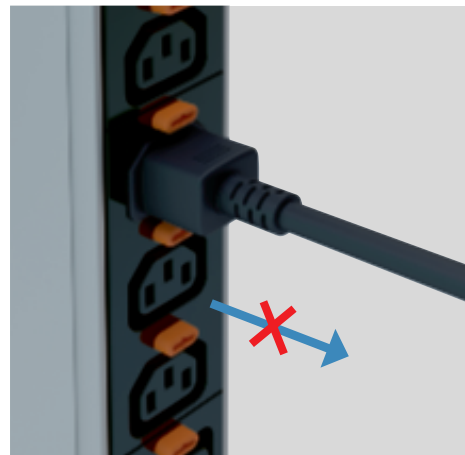

Cord held in place: once the power supply cord is connected, it locks automatically and cannot be removed

UNLOCKING

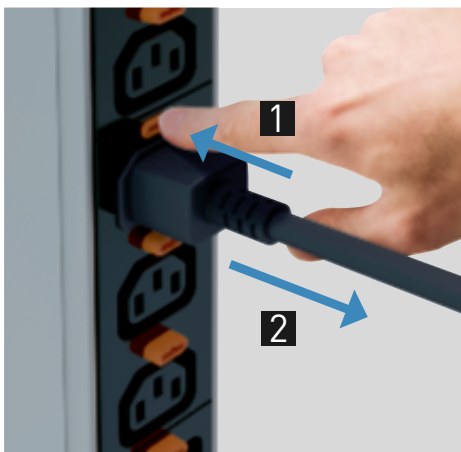

Easy removal: simply pressing the unlock button releases the cord from the socket

UNIVERSAL SYSTEM

Takes all cords for standard C13 and C19 sockets



✓ EXCLUSIVE TO LEGRAND

ZERO-U PDUs INNOVATION & PERFORMANCE

Exclusive innovations

Every detail matters! Legrand's unique and original innovations help ensure optimum performance for the ZERO-U range of PDUs, in terms of safety, simplified setup and integration, consumption indicators, etc.

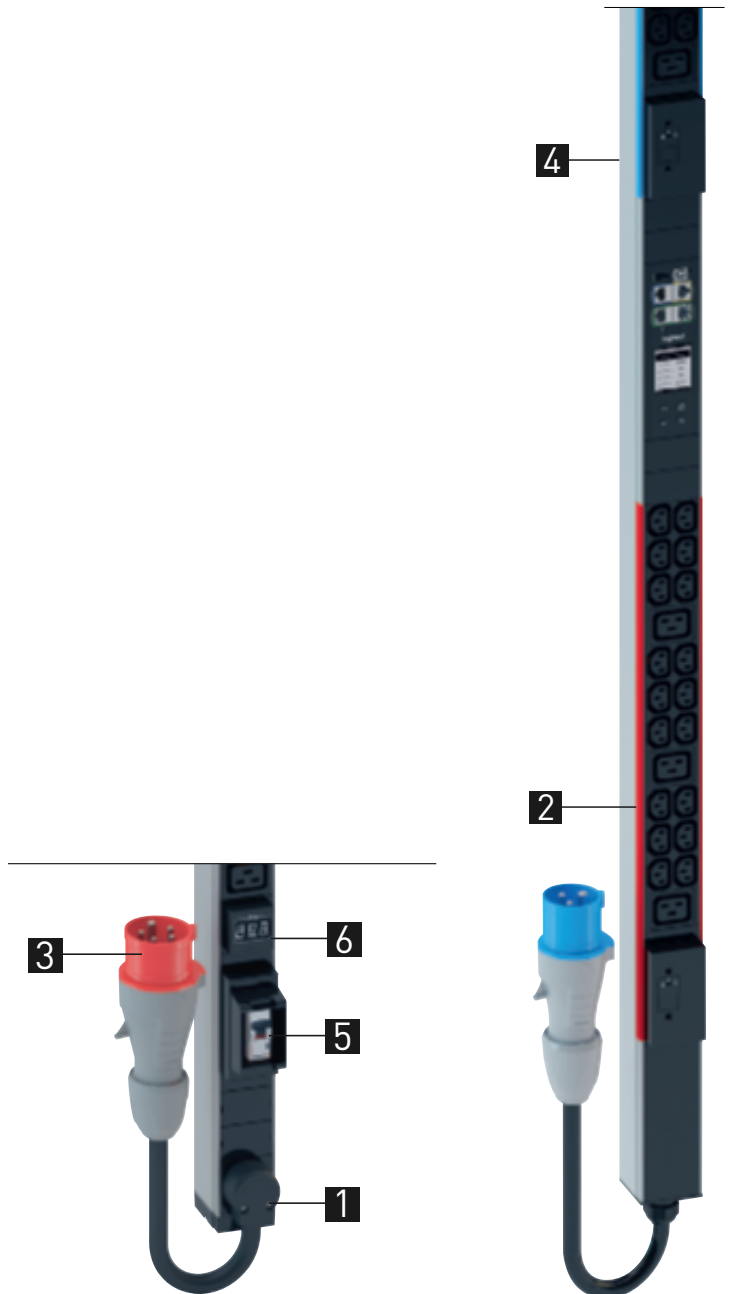

VERTICAL
INSTALLATION



STANDARD STRUCTURE FOR BASIC, METERED & SWITCHED PDUs

ROTATIVE CABLE ENTRY

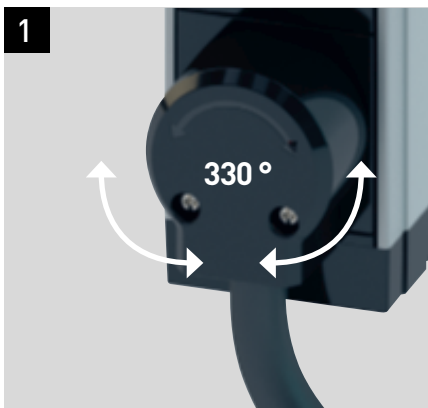

CABLE ORIENTATION

330° rotatable cable entry for perfect cable orientation and no interference in the cabinet

CIRCUIT MARKING

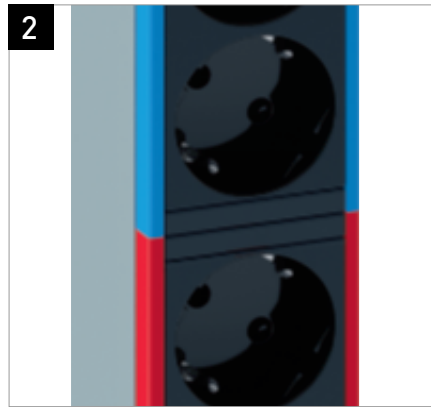

CIRCUIT IDENTIFICATION

Each circuit is colour-coded, with the colour visible on the front panel and along the edges of a module. The colour corresponds to the specific MCB protecting the circuit.

INPUT POWER

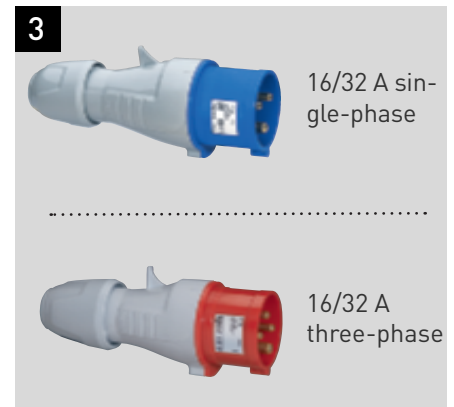

ENHANCED PROTECTION

There are multiple solutions depending on power supply requirements

OPTIONS FOR BASIC PDUs ONLY

SCREWLESS MOUNTING

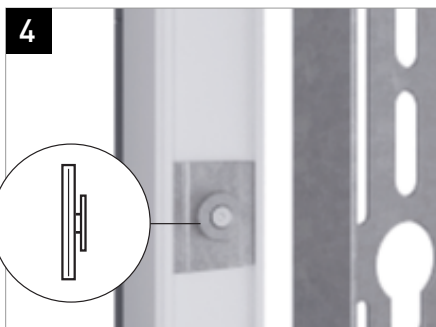

FIXED IN BUTTONHOLE SLOTS

ZERO-U PDUs simply clip vertically into buttonhole slots on the mounting bracket without the need for any screws.

CIRCUIT BREAKER HOLDER

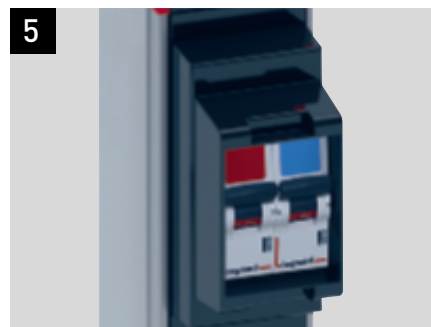

ENHANCED PROTECTION

Circuits protected by a circuit breaker. Holder with overhanging edges to prevent accidental breakages. (Cover available on request)

AMMETER



CONSUMPTION INDICATOR

- Circuit balancing
- Display of available capacity
- Overload prevention

✓ EXCLUSIVE TO LEGRAND

1-U PDUs
INNOVATION & CONVENIENCE
 Simple setup and integration

The 19" PDUs designed for installation in server cabinets and patch panels also incorporate the latest innovations for facilitating integration and maintenance, with clever mounting and operating features.

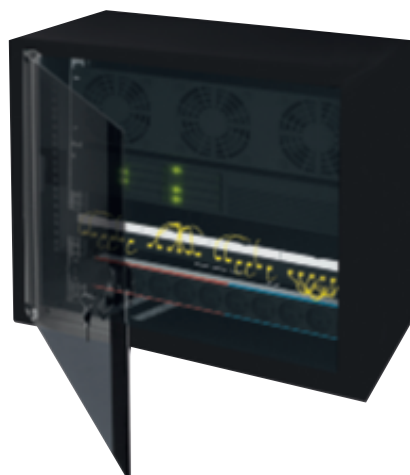
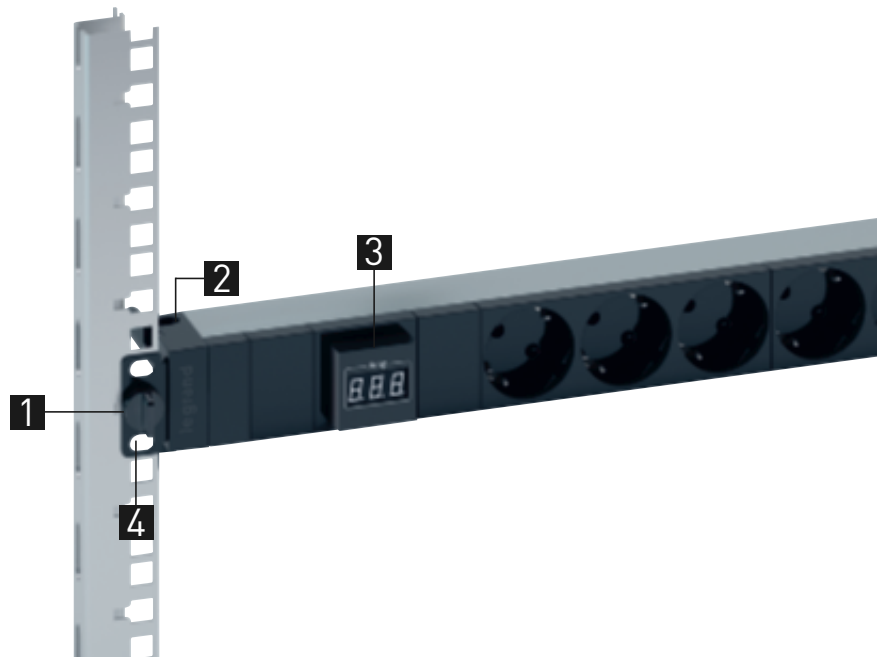

PDU 1 U 10"

Specially designed for local area networks, these PDUs feature the same innovations as the 19" range.

HORIZONTAL INSTALLATION 



HORIZONTAL
OR VERTICAL
INSTALLATION



SNAP-ON FIXING

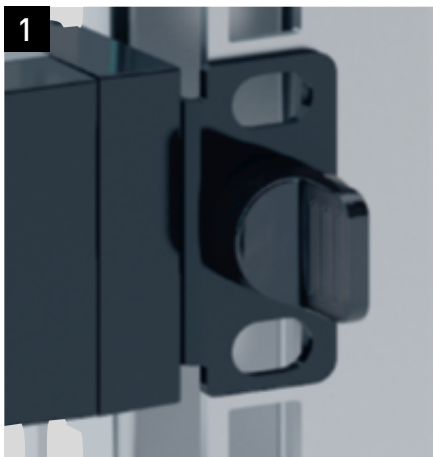

TOOLLESS INSTALLATION
Snap-on fixing on 19" uprights
No need for screws or nuts.
Toolless installation.

CABLE GUIDE

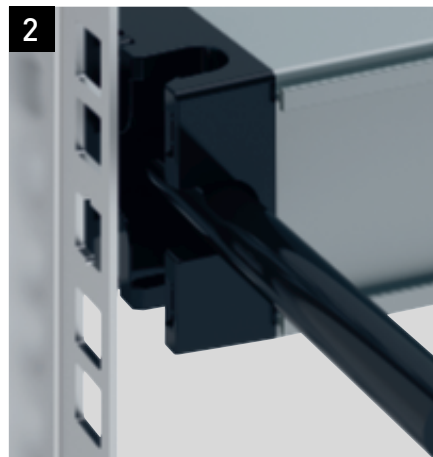

OPTIMISING SPACE
Cables are held firmly in place by a
cable guide.

AMMETER

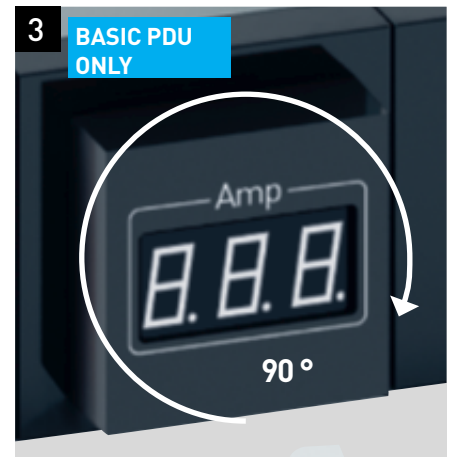

ROTATABLE DISPLAY
The ammeter can be rotated 90°
to ensure easy reading regardless
of mounting position (horizontal or
vertical).

MOUNTING BRACKETS

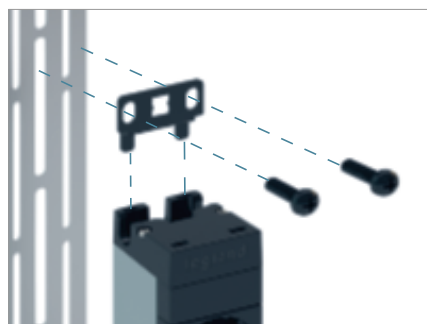
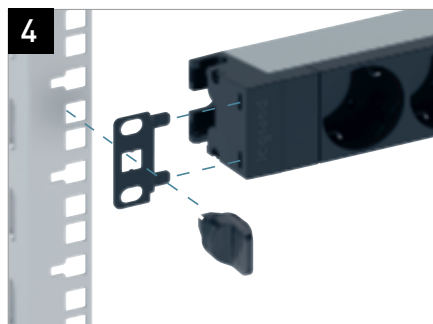

HORIZONTAL OR VERTICAL
Designed for horizontal toolless
mounting, 1-U PDUs can also
be mounted vertically simply by
rotating the mounting lugs. Vertical
mounting requires a bolt and nut
to fix the PDU securely to the bracket.

EXCLUSIVE TO LEGRAND

PDU: measurement, metering & consumption

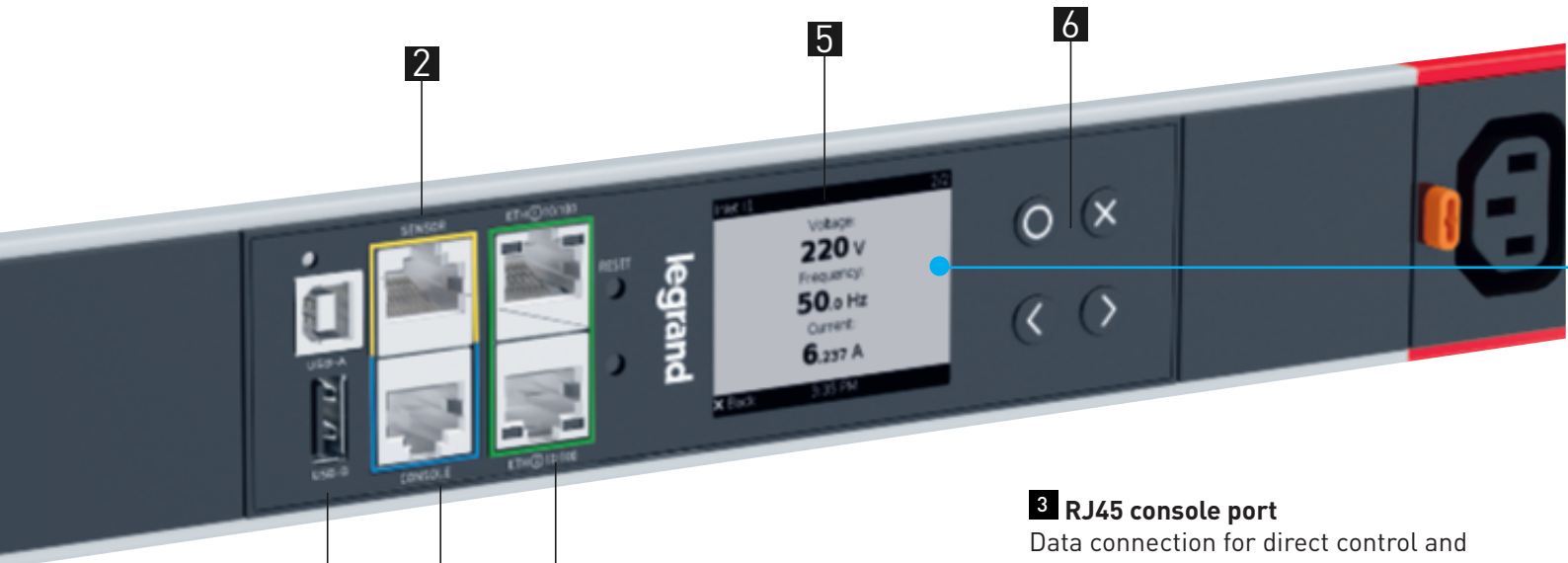

1



1 USB-A and B ports

USB A and B ports for connecting peripheral devices, so data can be viewed on smartphones



2 RJ45 sensor port

Plug & Play sensor port for directly connecting temperature and humidity sensors and the Raritan SmartSensor™ range

2



3

4

6

3 RJ45 console port

Data connection for direct control and management

4 Dual network ports

Dual network connection (Fast Ethernet), redundant and configurable for access to the PDU from 2 different networks, ideal for Colocation projects or for daisy-chaining PDUs

5 LCD color screen

220 X 176 mm super bright screen with configurable measurement data display

6 Intuitive navigation buttons

Navigation buttons for local screen

NEW CONTROLLER: THE HEART OF iPDUs

A wide, bright color LCD display

The new Legrand PDU controller allows local access to all critical measurement data. The bright color LCD display will change colour according to the alert level detected by the iPDUs; your field technicians can quickly identify iPDUs on which the thresholds have been exceeded, obtain correct power supply data immediately and take appropriate action.

LOCAL DISPLAY



ADAPTIVE COLOUR SCREEN

The LCD display on the unit changes colour according to the alert level, making it easier for the technical teams to see the information

DCIM MONITORING

Legrand Metered and Switched PDUs can be used to export measurement and control data to any DCIM platform such as Sunbird Power IQ .

NEW PDU HTML USER INTERFACE



DIRECTLY ACCESSIBLE DATA

Makes it easier to view the data center power supply data and information about the environment. The responsive Web graphic interface can be accessed from any device or tablet, or directly from a desktop computer. The redesigned overview screen

provides the most important information at a glance, so you can easily monitor your PDU health and critical data, and also view the cabinet energy consumption in real time.



METERED & SWITCHED iPDUs ADVANCED MONITORING

Gold standard accuracy

The first step in preventing outages in your data center consists of making sure that you have the most reliable and accurate monitoring data. Legrand iPDUs are certified to have +/- 1% measurement accuracy with all types of load in real time, you can be sure that your PDU is supplying the necessary information as and when needed.

ACCURATELY MEASURED ENERGY CONSUMPTION



REAL-TIME MEASUREMENT

Legrand PDUs are certified to have +/- 1% measurement accuracy with all types of load in real time, so you can be sure that your PDU is supplying the necessary information as and when needed.

With Legrand's Metered and Switched PDUs, a billing-grade energy metering chip is dedicated to the Inlet power supply module and provides extremely accurate KWH data for each tap-off circuit.

+/-1% HIGH-PERFORMANCE INPUT MEASUREMENT

Legrand PDUs benefit from the metering technology of Raritan, delivering a high-end measurement performance, which gives a clear picture of energy consumption.



CIRCUIT BREAKER INTELLIGENCE AND BRANCH CIRCUIT MONITORING

If a server power supply fails, your energy management system in the electrical panel will not detect this condition, only detection of the circuit breaker trip status will keep you informed in real time!

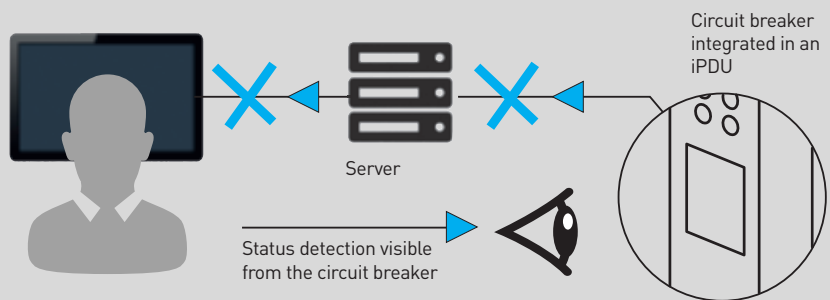

MONITORING CURRENT AND VOLTAGE AT THE CIRCUIT BREAKER LEVEL

Legrand iPDUs are equipped with standard Circuit breaker status monitoring and branch circuit metering (on 32A models), providing critical load-balancing and circuit load information per phase. This allows you to be alerted in time and avoid circuit overloads.

They can also be used to activate configurable alerts when a measurement is exceeded or when a circuit breaker drops. You are directly informed of the loss of power and can react quickly, preventing overloads on other circuits.

CIRCUIT OVERLOAD ALARM

Alarms defined by the user warn the IT managers and data centers of potential circuit overloads so as to prevent accidental loss of power to critical equipment.

SWITCHED iPDUs METERING & CONTROL Easier power management

Legrand iPDUs also integrate input metering and output level switching, providing granular power switching of each device connected to the iPDU, and making it easier to manage IT installations remotely, while helping to improve availability.



CONFIGURABLE OUTLET REBOOTING SCHEDULE

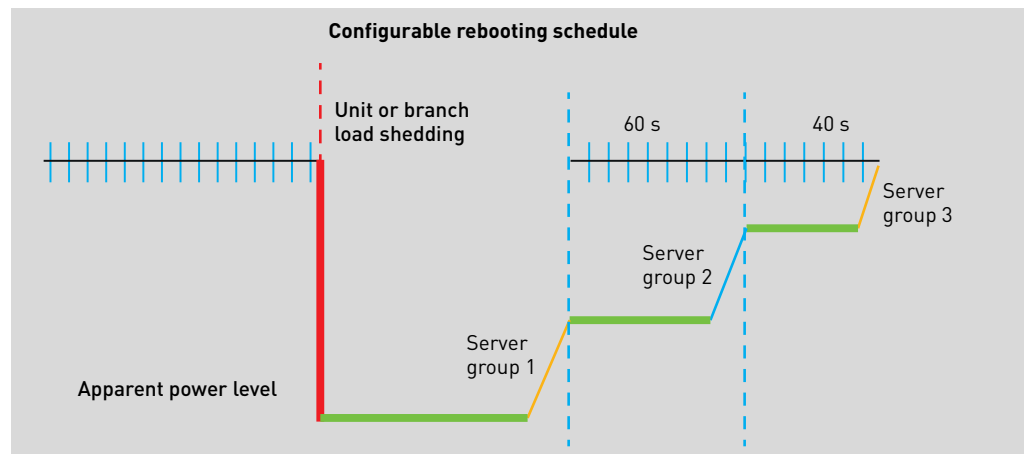

OUTPUT CONTROL

Automated restarting, load shedding and individual output control of socket outlets. Used to schedule restarting on each socket outlet in order to minimise the impact of the peak current on the servers.

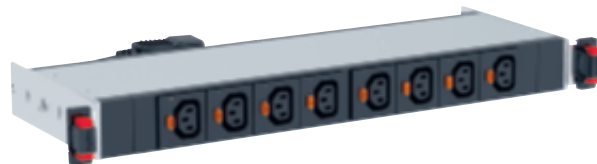

AVAILABLE IN VERTICAL ZERO-U
 AND HORIZONTAL 1U 19" VERSIONS

CIRCUIT BREAKER INTELLIGENCE



MAGNETIC-HYDRAULIC CIRCUIT BREAKER

Above 16 Amps, Legrand iPDUs have rugged circuit breakers with delayed tripping curve, guaranteeing maximum flexibility and safety of people and equipment.

The circuit breakers are monitored by the embedded firmware and issue configurable alerts in the event of an overload or unwanted tripping.

REMOTE SOCKET OUTLET MANAGEMENT

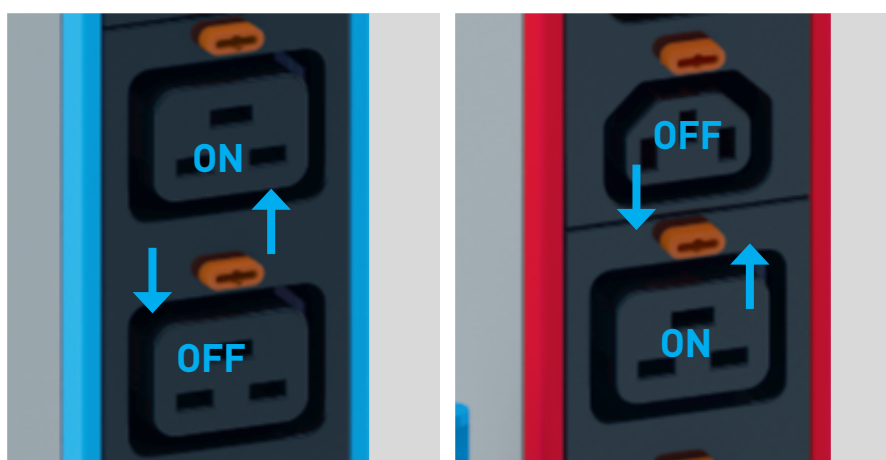

CONFIGURABLE CIRCUIT MANAGEMENT

Option of remotely switching sockets between one another and activating or deactivating individual sockets in real time on the network and managing the power sequencing of your device.

The use of switched models allows users to deactivate unavailable sockets remotely and avoid overloading the circuits by plugging in additional devices.

PROTECTION AGAINST UNCONTROLLED CONNECTIONS



REMOTE SOCKET MANAGEMENT

Remote socket management prevents human errors and can check that devices are only plugged in on available circuits, thus preventing overloads.



METERED iPDUs ENERGY METERING

See all consumption
at a glance

Legrand iPDUs incorporate input metering, allowing accurate measurement of the unit's energy consumption, making it easy to understand power and manage data center growth.



CONNECTED LOADS



EASIER DATA COLLECTION IN THE CABINET

No more need to call in the technical teams to take on-site measurements in order to find out the energy consumption of your equipment, your intelligent iPDU takes care of it for you....

UNIT POWER

The overview of the rack power capacity and energy use makes it easy to understand clearly the remaining capacity in the cabinet so as to assist decisions about future growth.

Metered & switched with Raritan peripherals

By incorporating the Raritan technology platform, Legrand iPDUs benefit from the whole range of **SmartLock™** electronic door handles, and **SmartSensor™** environmental monitoring products. These plug and play peripherals make it easy to oversee the whole installation directly from your iPDU!

SmartSensor™ includes: temperature, humidity and contact closure sensors.

SmartLock™ includes: simple electronic handles, plus 125 kHz and 13.56 MHz card reader handles.

RARITAN SMARTSENSORS™

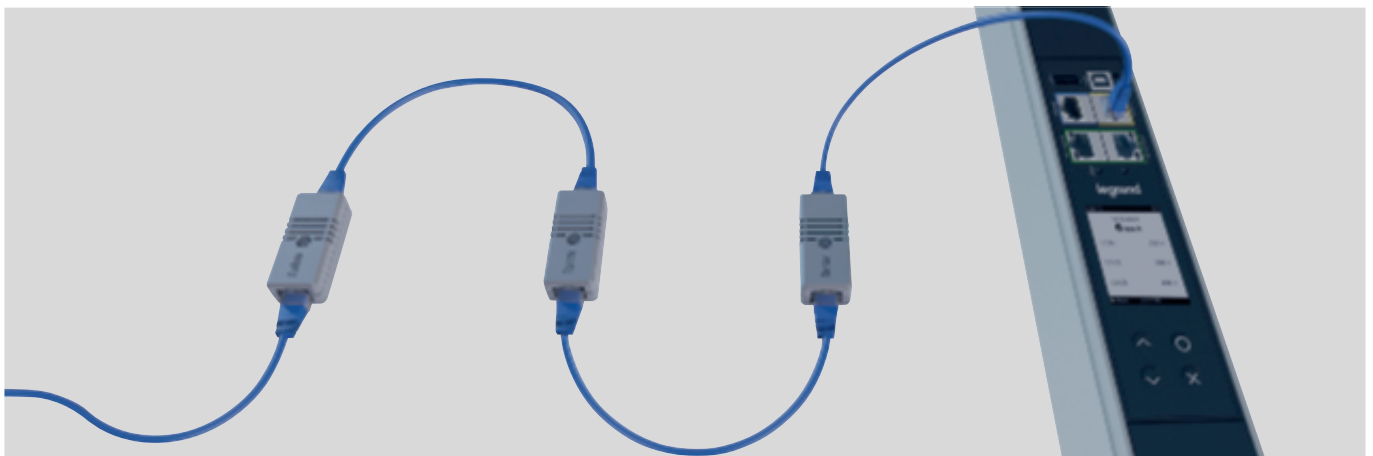

EASIER CONNECTION AND INTEGRATION

RJ45 technology simplifies the connectivity and implementation of sensors. All Raritan SmartSensors are easily integrated in the cabinet

and can be connected in a daisy-chain and replaced without having to rewire the cabinet.

www.raritan.com/smartsensors

RARITAN SMARTLOCK™

SIMPLIFIED ACCESS, CONTROL AND COMPLIANCE

Plug and Play with Raritan SmartLock™ electronic handles, Legrand iPDUs allow you to control and secure access to the cabinet with ease

www.raritan.com/smartlock



PDUs: accessories for protection

ENHANCED SAFETY AND CONTROL

Compatible with all the PDUs in the Legrand range, the complementary accessories allow you to control the socket power supply and protect against overvoltages.

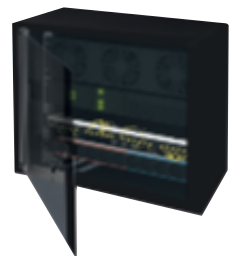

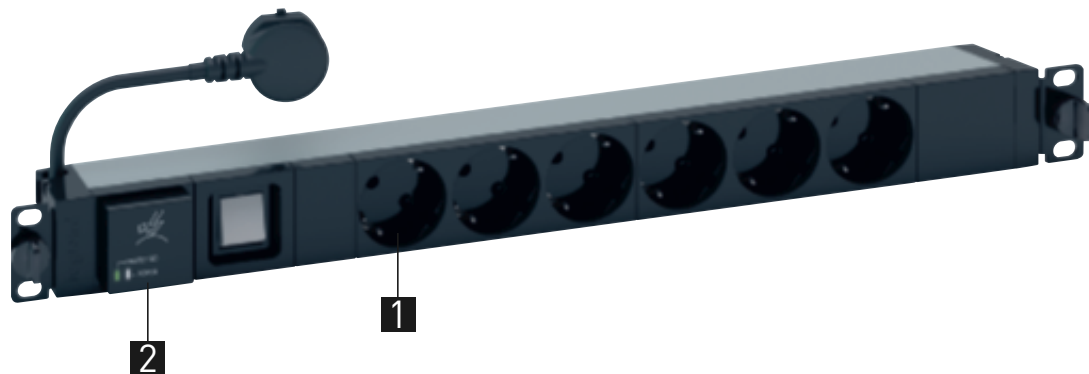

SOCKET LOCKING CAP



CONTROLLING ACCESS TO THE POWER SUPPLY

The locking cap can be used to lock access to a socket. A special key is required to unlock it.

Locking caps are available for the following socket standards: C13, C19, German, French-Belgian, British.



SURGE PROTECTIVE DEVICE



MODULAR SURGE PROTECTION

The surge protection module protects equipment against overvoltages and incorporates hot swap technology. It can be used to replace a used module without interrupting the power supply to the other equipment connected to the PDU.

This is an essential accessory for business servers which need continuous protection. The module is equipped with a warning LED which indicates when it needs replacing.

EXCLUSIVE TO LEGRAND

Support you can rely on

It takes more than just sophisticated technological solutions to manage international projects successfully. What is really needed is the comprehensive and expert support of an experienced partner: from project design and choice of the right solution through to on-site logistics, installation and configuration, including any subsequent troubleshooting and maintenance.

Legrand is ideally placed to offer this type of support, as all its products and solutions are developed and produced in close proximity to its customers. It also offers a wide range of special services and support tools which create genuine added value by making customers' day-to-day business significantly easier. This support is available at every stage of the project, whatever the customer touchpoint.





01 A diverse range of digital tools including websites, social media and news feeds so you can contact Legrand at any time and stay up to date with all essential news that is relevant to your projects.



02 Personal advice, technical support and documents, white papers, catalogues and e-catalogues, mobile apps, and software to help with product choice or drawing up bills of materials.

03 Training courses covering actual product expertise as well as the latest developments in technology, standards and regulations. Customised training courses available on request, either face to face or in virtual online classes.



Confident in the quality of its solutions, Legrand offers to warranty continuity of performance of its cabling system for copper and/or fibre optic over 25 years.

Evolution of standard 11801 Edition 3 - 2018

Introduction

Within customer premises, the importance of the cabling infrastructure is similar to that of other fundamental building utilities such as heating, lighting and mains power. As with other utilities, interruptions to service can have a serious impact. Poor quality of service due to lack of design foresight, use of inappropriate components, incorrect installation, poor administration or inadequate support can threaten an organisation's effectiveness.

Historically, the cabling within premises comprised both application-specific and multipurpose networks. The original edition of this standard enabled a controlled migration to generic cabling and the reduction in the use of application-specific cabling. The subsequent growth of generic cabling designed in accordance with ISO/IEC 11801 has:

- a) contributed to the economy and growth of Information and Communications Technology (ICT)
 - b) supported the development of high data rate applications based upon a defined cabling model, and
 - c) initiated development of cabling with a performance surpassing the performance classes specified in ISO/IEC 11801:1995 and subsequent editions:
- ISO/IEC 11801:1995 (Ed. 1) - first edition
 - ISO/IEC 11801:2000 (Ed. 1.1) - Edition 1, Amendment 1
 - ISO/IEC 11801:2002 (Ed. 2) - second edition
 - ISO/IEC 11801:2008 (Ed. 2.1) - Edition 2, Amendment 1
 - ISO/IEC 11801:2010 (Ed. 2.2) - Edition 2, Amendment 2

The 3rd Edition of ISO/IEC 11801 is now a multipart standard with the structure shown below. It is at the Final Draft International Standard (FDIS) stage in 2017, and is due to be published in early 2018:

ISO/IEC 11801 3rd Edition

General requirements (11801-1)
Specific requirements for premises:
- Offices & commercial buildings (11801-2)
- Industrial premises (11801-3)
- Homes (11801-4)
- Data centers (11801-5)
- Distributed building services (11801-6)

The International Standard ISO/IEC 11801-1 will specify requirements for balanced twisted-pair copper (Classes A, B, C, D, E, EA, F, FA, I and II), and fibre optic (OM1, OM2, OM3, OM4, OM5, OS1a, and OS2) cabling systems used in offices (ISO/IEC 11801-2), industrial buildings (ISO/IEC 11801-3), homes (ISO/IEC 11801-4), data centers (ISO/IEC 11801-5), and for the distribution of services in buildings (ISO/IEC 11801-6). This standard series will specify the structure and minimum configurations of generic cabling, performance requirements of channels, links, connecting hardware and cords, implementation requirements, compliance requirements and verification procedures, and interfaces. Requirements for cable performance are made via reference to applicable IEC standards.

Dealing with balanced twisted-pair cabling, new Classes I and II are specified with Category 8.1 (RJ45 connectors) and Category 8.2 (proprietary connector) components respectively.

Balanced Twisted-Pair Class Specifications of ISO/IEC 11801-1:

- Class A is specified up to 100 kHz
- Class B is specified up to 1 MHz
- Class C is specified up to 16 MHz
- Class D is specified up to 100 MHz
- Class E is specified up to 250 MHz
- Class EA is specified up to 500 MHz
- Class F is specified up to 600 MHz
- Class FA is specified up to 1000 MHz
- Class I and Class II are specified up to 2000 MHz

Significant changes from the previous edition include: Class I and II channel and link requirements have been added

- Category 8.1 and 8.2 connecting hardware and cord requirements have been added
- Cabled OM1, OM2, and OS1 optical fibre is no longer recommended for new installations
- Cabled wideband OM4 (OM5) and OS1a optical fibre requirements have been added

This International Standard provides:

- a) users with an application-independent generic cabling system capable of supporting a wide range of applications
- b) users with a flexible cabling scheme making modifications both easy and economical
- c) building professionals (for example, architects) with guidance allowing the accommodation of cabling before specific requirements are known; that is, in the initial planning for either new construction or refurbishment
- d) industry and application standardisation bodies with a cabling system which supports current products and provides a basis for future product development.

This International Standard specifies a multi-vendor cabling system which can be implemented with material from single and multiple sources, and is related to:

- a) international standards for cabling components developed by committees of the IEC, for example copper cables and connectors as well as fibre optic cables and connectors (see Clause 2 and bibliography)
- b) standards for the installation and operation of information technology cabling as well as for the testing of installed cabling (see Clause 2 and bibliography)
- c) applications developed by technical committees of the IEC, by subcommittees of ISO/IEC JTC 1 and by study groups of IEEE 802 and ITU-T, for example for LANs and ISDN
- d) planning and installation guides which take into account the needs of specific applications for the configuration and the use of cabling systems on customer premises (for example ISO/IEC 14709 series, ISO/IEC 14763 series, ISO/IEC 30129, and ISO/IEC 18598).

Physical layer requirements for the applications listed in Annex E have been analysed to determine their compatibility with the cabling classes specified in this standard. These application requirements, together with statistics concerning the topology of premises and the model described in ISO/IEC 11801-2 clause 8.2, have been used to develop the requirements for Classes A to FA and fibre optic cabling systems.

In offices horizontal balanced cabling should now be designed to provide minimum Class E, and minimum Class EA is recommended to support applications with data rates exceeding 1 Gigabit/sec.

Scopes

Scope of ISO/IEC 11801-1: Generic cabling for customer premises – Part.1 General requirements

This International Standard specifies requirements that are common to the other parts of the ISO/IEC 11801 series. Cabling specified by this standard supports a wide range of services including voice, data, and video that may also incorporate the supply of power.

This International Standard specifies:

- a) The fundamental structure and configuration of generic cabling requirements within the type 400 premises defined by the other standards in the ISO/IEC 11801 series
- b) channel transmission and environmental performance requirements
- c) link performance requirements
- d) component performance requirements, referring to available International Standards for 404 components and test methods where appropriate
- e) test procedures to verify compliance with the cabling transmission performance requirements 406 of the 11801 series documents.

Note: This International Standard does not contain specific compliance requirements. The cabling design documents supported by ISO/IEC 11801-1 incorporate the requirements of this standard as part of their individual compliance requirements.

In addition, ISO/IEC 11801-1 provides information regarding the applications supported by the cabling channels. ISO/IEC 11801-1 has taken into account requirements specified in the application standards listed in Annex E.

Scope of ISO/IEC 11801-2 – Generic cabling for customer premises – Part.2 Office premises

This International Standard specifies generic cabling for use within office premises, which may comprise single or multiple buildings on a campus. It covers balanced cabling and fibre optic cabling.

ISO/IEC 11801-2 is optimised for premises where the maximum distance over which telecommunications services can be distributed is 2000 m. The principles of this International Standard may be applied to larger installations.

Cabling specified by this standard supports a wide range of services including voice, data, and video that may also

incorporate the supply of power.

This International Standard specifies directly or via reference to ISO/IEC 11801-1:

- a) the structure and minimum configuration for generic cabling within office premises
- b) the interfaces at the telecommunications outlet (TO)
- c) the performance requirements for cabling links and channels
- d) the implementation requirements and options
- e) the performance requirements for cabling components
- f) the compliance requirements and verification procedures.

ISO/IEC 11801-2 has taken account of the requirements specified in application standards listed in ISO/IEC 11801-1:201X, Annex E.

Safety (e.g. electrical safety and protection and fire) and Electromagnetic Compatibility (EMC) requirements are outside the scope of this International Standard, and are covered by other standards and by regulations. However, information given by this standard may be of assistance.

Scope of ISO/IEC 11801-6 – Generic cabling for customer premises – Part. 6 Distributed building services.

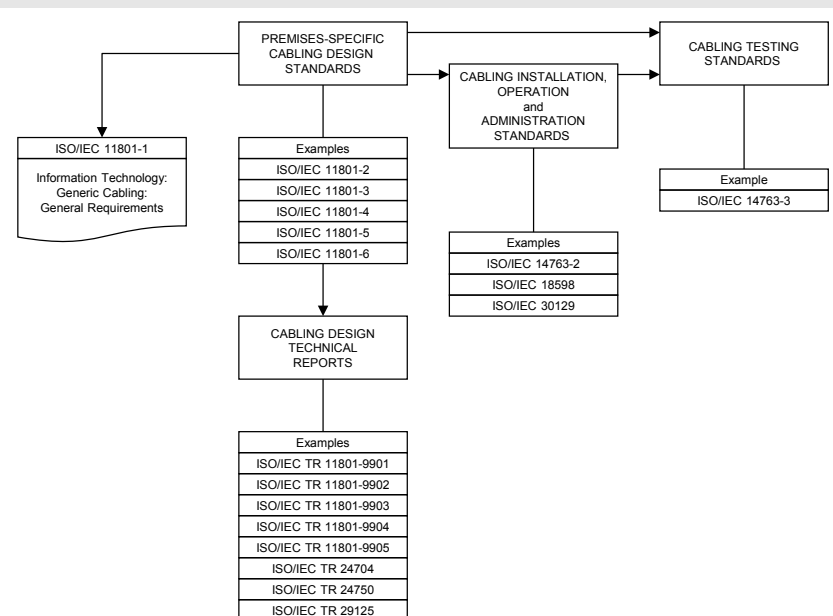

The information in this Figure is not automatically updated following the introduction, or removal, of international standards or Technical Reports

Source: ISO/IEC 11801-1 (2017)

The figure shows the schematic and contextual relationships between the standards relating to information technology cabling produced by ISO/IEC JTC 1/SC 25, namely the ISO/IEC 11801 series of standards for generic cabling design, standards for the installation, operation and administration of generic cabling and for testing of installed generic cabling.

The life expectancy of generic cabling systems can vary depending on environmental conditions, supporting applications, ageing of materials used in cables, and other factors, such as access to pathways (campus pathways are more difficult to access than building pathways). With appropriate choice of components, generic cabling systems meeting the requirements of this International Standard are expected to have a life expectancy of at least ten years.

CPR – Construction Products Regulation

The aim of the CPR regulation is to guarantee the free circulation of products made in the European Union, adopting a harmonised technical language which can define the performance and essential features of all construction products.

Electrical cables are rarely the cause of a fire but when they are involved they may form a seriously hazardous component because of their large quantities and because they are found in all rooms of the building. With careful prevention and making state-of-the-art systems with safe and high-quality components in accordance with the CPR regulation, fire propagation, the lack of visibility in smoke-filled rooms and the diffusion of corrosive and toxic gases can be reduced or almost totally eliminated.

The CPR regulation (EU 305/2011) concerns all the products made to be permanently incorporated (installed/used) in buildings and other civil engineering works (e.g. homes, industrial and commercial buildings, offices, hospitals, schools, undergrounds, etc.). As part of the features considered important for the safety of constructions included in the CPR, the European Commission has decided to consider cables' Reaction to Fire and Resistance to Fire, recognising the importance of their behaviour and role in fire. The release of harmful substances is one of the performances considered important for cables, although at present no minimum levels of performance have been established because when used normally the cables do not release harmful substances.

All the cables installed permanently in constructions, to transport power or for telecommunications, of any voltage level and with copper or fibre optic conductors, must be classified on the basis of the classes of premises where they will be installed.

The cables are classified in 7 classes of Reaction to Fire: Aca, B1ca, B2ca, Cca, Dca, Eca and Fca identified by the subscript "ca" (cable) as a function of their decreasing performance. As well as this main classification, the European authorities have also regulated the use of the following additional parameters:

- **a** = acidity which defines the hazard of the fumes for people and the corrosiveness for things. Varies from a1 to a3
- **s** = opaqueness of the smoke. Varies from s1 to s3
- **d** = dropping of incandescent particles which could propagate fire. Varies from d0 to d2.





A more severe check (System 1+) is required for the classes from Aca to Cca. It lays down the initial check and continuous monitoring of the product and checks of the manufacturing control system, while for the classes from Dca to Eca the check only lays down the initial product check (System 3). Class F, however, is based on the manufacturer's self-declaration (System 4).

The table below contains the classification of cables according to the test requirements of the CPR Regulation and the correlation between the cable classification and the most representative installation rooms.

	Euroclass	Classification criteria	Additional criteria	AVCP system (Assessment and Verification of Consistency of Performance)
Non combustible (e.g. mineral insulated)	A_{ca}	EN ISO 1716 Gross heat of combustion		<p>"1+", including:</p> <ul style="list-style-type: none"> initial type-testing and continuous surveillance Audit & testing of samples by 3rd party certification body <p>Factory production controls by manufacturer</p>
Low-Fire-Hazard cables (various levels)	B1_{ca}	EN 50399 Heat release Flame spread	Smoke production (s1a, s1b, s2, s3) EN50399/EN61034-2 Acidity (a1, a2, a3) EN 50267-2-3 Flaming droplets (d0, d1, d2) EN 50399	<p>"3", including:</p> <ul style="list-style-type: none"> initial type-testing by 3rd-party laboratory <p>Factory production controls by manufacturer</p>
	B2_{ca}			
	C_{ca}	EN 60332-1-2 Flame propagation		
	D_{ca}			
Standard cables	E_{ca}	EN 60332-1-2 Flame propagation		<p>Factory production controls by manufacturer</p>
No performance determined	F_{ca}	EN 60332-1-2 Flame propagation		<p>"4"</p> <p>initial type-testing and factory production controls by manufacturer</p>



FOLLOW US ALSO ON

- @ legrand.com
-  youtube.com/user/legrand
-  facebook.com/Legrand
-  twitter.com/Legrand
-  pinterest.com/legrandgroup
-  instagram.com/legrandnews



Headquarters

128, avenue de Lattre de Tassigny
87045 Limoges Cedex
France
Tel.: + 33 (0) 5 55 06 87 87
Fax: + 33 (0) 5 55 06 88 88